



**HIRDAVAT
GRUBU
HARDWARES**

STD ASMA KİLİTLER

STD PADLOCKS

STD VORHÄNGESCHLÖSSER



ÖLÇÜLERİ DIMENSIONS MASSE	20mm	25mm	32mm	38mm	50mm	63mm
AĞIRLIK WEIGHT GEWICHT	32	50	93	144	310	540
GÖVDE MALZEMESİ BODY MATERIAL KÖRPERMATERIAL	MALZEME ÇELİK, SARILAR PİRİNÇ; GRİLER SİYAH KAPLAMA MATERIAL STEEL, YELLOWS BRASS; GRAY BLACK PLATING MATERIAL STAHL, GELBES MESSING; GRAUER SCHWARZER ÜBERZUG					
KANCA MALZEMESİ HOOK MATERIAL HAKENMATERIAL	MALZEME ÇELİK, KAPLAMA KROM MATERIAL STEEL, PLATED CHROME MATERIAL STAHL, VERCHROMT					
İÇ SİLİNDİR MALZEMESİ INSIDE CYLINDER MATERIAL INNERES ZYLINDERMATERIAL	TAMAMI PİRİNÇ SİLİNDİR ALL BRASS CYLINDER ALLE MESSINGZYLINDER					
ANAHTAR MALZEMESİ KEY MATERIAL SCHLÜSSELMATERIAL	MALZEME ÇELİK, KAPLAMA NİKEL MATERIAL STEEL, PLATED NICKEL MATERIAL STAHL, NICKEL BESCHICHTET					
SIZDIRMAZLIK LASTİĞİ SEALING RUBBER DICHTUNGSGUMMI	20 ve 25mm HARIÇ HEPSİNDE BULUNUR. VERFÜGBAR FÜR ALLE AUSSER 20 und 25 mm. AVAILABLE ON ALL EXCEPT 20 and 25mm.					

TEKNİK ÖLÇÜLERİ TECHNISCHE ABMESSUNGEN TECHNICAL DIMENSIONS	20mm	25mm	32mm	38mm	50mm	63mm	
	A	21	25	32	38	50	63
	B	19,5	24,5	30	35	43	50
	C	11	12,5	15	17	23	26,5
	D	3,2	4,3	5,3	6,2	8,8	10,5
	E	10,5	12	16	19,5	27	32
	F	11,5	15	19	19,5	27	35

STDeKko ASMA KİLİTLER

STDeKko PADLOCKS

STDeKko VORHÄNGESCHLÖSSER



ÖLÇÜLERİ DIMENSIONS MASSE	25mm	32mm	38mm	50mm	63mm
AĞIRLIK WEIGHT GEWICHT	34	63	100	215	360
GÖVDE MALZEMESİ BODY MATERIAL KÖRPERMATERIAL	MALZEME DEMİR, SARI VE SİYAH KAPLAMA MATERIAL IRON, YELLOW AND BLACK PLATING MATERIAL EISEN, GELB UND SCHWARZ BESCHICHTET				
KANCA MALZEMESİ HOOK MATERIAL HAKENMATERIAL	MALZEME DEMİR, KAPLAMA KROM MATERIAL IRON, PLATED CHROME MATERIAL EISEN, VERCHROMT				
İÇ SİLİNDİR MALZEMESİ INSIDE CYLINDER MATERIAL INNERES ZYLINDERMATERIAL	SİLİNDİR DEMİR, UÇ KISMI PİRİNÇ CYLINDER IRON, END PART BRASS ZYLINDEREISEN, ENDTEIL MESSING				
ANAHTAR MALZEMESİ KEY MATERIAL SCHLÜSSELMATERIAL	MALZEME DEMİR, KAPLAMA KROM MATERIAL IRON, PLATED CHROME MATERIAL EISEN, VERCHROMT				
SIZDIRMAZLIK LASTİĞİ SEALING RUBBER DICHTUNGSGUMMI	HIÇBİR ÖLÇÜDE BULUNMAZ NOT AVAILABLE TO ANY SIZE NICHT IN JEDER GRÖSSE VERFÜGBAR				

TEKNİK ÖLÇÜLERİ TECHNISCHE ABMESSUNGEN TECHNICAL DIMENSIONS	25mm	32mm	38mm	50mm	63mm	
	A	25	32	37	48	61
	B	24	28	32	40	49
	C	12	13	13	18	20
	D	14	17	21	26	32
	E	4	4,5	5,5	7	8,5
	F	13	16	20	25	31

STD UZUN KANCALI ASMA KİLİTLER

STD LONG HOOK PADLOCKS

STD LANGE HAKENSCHLÖSSER



ÖLÇÜLERİ DIMENSIONS MASSE	32mm	38mm	50mm	63mm
AĞIRLIK WEIGHT GEWICHT	100	168	320	540
GÖVDE MALZEMESİ BODY MATERIAL KÖRPERMATERIAL	MALZEME ÇELİK, SARILAR PİRİNÇ; GRİLER SİYAH KAPLAMA MATERIAL STEEL, YELLOWS BRASS; GRAY BLACK PLATING MATERIAL STAHL, GELBES MESSING; GRAUER SCHWARZER ÜBERZUG			
KANCA MALZEMESİ HOOK MATERIAL HAKENMATERIAL	MALZEME ÇELİK, KAPLAMA KROM MATERIAL STEEL, PLATED CHROME MATERIAL STAHL, VERCHROMT			
İÇ SİLİNDİR MALZEMESİ INSIDE CYLINDER MATERIAL INNERES ZYLINDERMATERIAL	SİLİNDİR ÇELİK, UÇ KISMI PİRİNÇ CYLINDER STEEL, END BRASS ZYLINDER STAHL, ENDE MESSING			
ANAHTAR MALZEMESİ KEY MATERIAL SCHLÜSSELMATERIAL	MALZEME ÇELİK, KAPLAMA NİKEL MATERIAL STEEL, PLATED NICKEL MATERIAL STAHL, NICKEL BESCHICHTET			
SIZDIRMAZLIK LASTİĞİ SEALING RUBBER DICHTUNGSGUMMI	HEPSİNDE BULUNUR. HAS EVERYTHING. HAT ALLES.			

TEKNİK ÖLÇÜLERİ TECHNISCHE ABMESSUNGEN TECHNICAL DIMENSIONS	32mm	38mm	50mm	63mm	
	A	32	38	50	63
	B	30	35	42	52
	C	15	17	21,5	25
	D	5,1	6,1	8	9,8
	E	16	19,5	27	32
	F	48	60	64	65

STD KAYAR MİLLİ ASMA KİLİTLER

STD SLIDING SHAFT PADLOCKS

STD SCHIEBEWELLEN-VORSCHLÖSSER

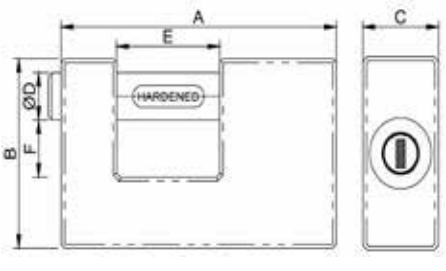

ÖLÇÜLERİ DIMENSIONS MASSE	70mm	80mm	90mm
AĞIRLIK WEIGHT GEWICHT	427	481	534
GÖVDE MALZEMESİ BODY MATERIAL KÖRPERMATERIAL	MALZEME ÇELİK, SARILAR PİRİNÇ; GRİLER NİKEL KAPLAMA MATERIAL STAHL, GELBES MESSING; GRAUE VERNICKELUNG MATERIAL STEEL, YELLOWS BRASS; GRAY NICKEL PLATING		
KANCA MALZEMESİ HOOK MATERIAL HAKENMATERIAL	MALZEME ÇELİK, KAPLAMA KROM MATERIAL STEEL, PLATED CHROME MATERIAL STAHL, VERCHROMT		
İÇ SİLİNDİR MALZEMESİ INSIDE CYLINDER MATERIAL INNERES ZYLINDERMATERIAL	TAMAMI PİRİNÇ SİLİNDİR ALL BRASS CYLINDER ALLE MESSINGZYLINDER		
ANAHTAR MALZEMESİ KEY MATERIAL SCHLÜSSELMATERIAL	MALZEME ÇELİK, KAPLAMA NİKEL MATERIAL STEEL, PLATED NICKEL MATERIAL STAHL, NICKEL BESCHICHTET		

TEKNİK ÖLÇÜLERİ TECHNISCHE ABMESSUNGEN TECHNICAL DIMENSIONS	70mm	80mm	90mm	
	A	70	80	90
	B	55	55	55
	C	20	20	20
	D	11	11	11
	E	24	30	30
	F	32	32	32

STD ŞİFRELİ KİLİTLER

STD ENCRYPTED LOCKS

VERSCHLÜSELTE STD-SPERREN



ÖLÇÜLERİ DIMENSIONS MASSE	20mm	28mm	38mm
AĞIRLIK WEIGHT GEWICHT	50	117	202
GÖVDE MALZEMESİ BODY MATERIAL KÖRPERMATERIAL	PRİNÇ GÖVDE BRASS BODY MESSINGKÖRPER	PRİNÇ GÖVDE BRASS BODY MESSINGKÖRPER	PRİNÇ GÖVDE BRASS BODY MESSINGKÖRPER
KANCA MALZEMESİ HOOK MATERIAL HAKENMATERIAL	ÇELİK KANCA STEEL HOOK STAHLHAKEN	ÇELİK KANCA STEEL HOOK STAHLHAKEN	ÇELİK KANCA STEEL HOOK STAHLHAKEN
BASAMAK SAYISI NUMBER OF STEPS ANZAHL DER SCHRITTE	3 KOMBİNASYONLU 3 COMBINATIONS 3 KOMBINATIONEN	3 KOMBİNASYONLU 3 COMBINATIONS 3 KOMBINATIONEN	4 KOMBİNASYONLU 4 COMBINATIONS 4 KOMBINATIONEN







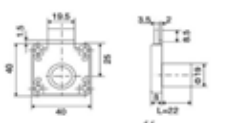

TEKNİK ÖLÇÜLERİ TECHNISCHE ABMESSUNGEN TECHNICAL DIMENSIONS	20mm	28mm	38mm	
	A	21	30	40
	B	30	31	39,5
	C	10	11	12
	D	3	4	5

ÇEKMECE KİLİTLERİ

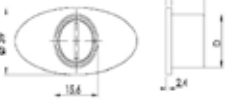
DRAWER LOCKS

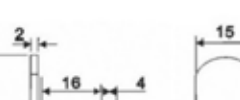
SCHUBLADENSCHLÖSSER

ÜRÜN TANIMI PRODUCT DESCRIPTION PRODUKTBESCHREIBUNG		DETAY DETAIL DETAIL
NO 138-22C	KARE ÇEKMECE KİLİDİ SQUARE DRAWER LOCK QUADRATISCHES SCHUBLADENSCHLOSS	Sac malzemeden yapılmaktadır. Kilit dili demirdir. Arka kısmı, gövde ve iç kapağı çeliktir. Mat nikel kaplamadır. Döndürme açısı saat yönünde 180°dir. 2 kırılabilir anahtarı vardır. It is made of sheet material. The lock tongue is iron. The back, body and inner cover are steel. Matt nickel plated. The rotation angle is 180° clockwise. It has 2 breakable keys.
NO 106C	OVAL ÇEKMECE KİLİDİ OVAL DRAWER LOCK OVALES SCHUBLADENSCHLOSS	Es besteht aus Plattenmaterial. Die Schloßzunge ist aus Eisen. Die Rückseite, der Körper und die innere Abdeckung sind aus Stahl. Matt vernickelt. Der Drehwinkel beträgt 180° im Uhrzeigersinn. Es hat 2 zerbrechliche Schlüssel.
NO 103-16	POSTA KUTUSU KİLİDİ MAILBOX LOCK BRIEFKASTENSCHLOSS	103-16; 103-20 ve 103-25 ölçülerindedir. Kilit göbeği 19mm'dir. Zamak kalıp dökümlü gövdesi ve silindiri vardır. Krom kaplamadır. Döndürme açısı saat yönünde 90 derecedir. 2 kırılabilir anahtarı vardır. 103-16; It is in sizes 103-20 and 103-25. Lock core is 19mm. It has a zamak die-cast body and cylinder. It is chrome plated. The rotation angle is 90 degrees clockwise. It has 2 breakable keys.
NO 103-20		
NO 103-25		103-16; Es ist in den Größen 103-20 und 103-25 erhältlich. Schloßkern ist 19 mm. Gehäuse und Zylinder aus Zamak-Druckguss. Es ist verchromt. Der Drehwinkel beträgt 90 Grad im Uhrzeigersinn. Es hat 2 zerbrechliche Schlüssel.
288-19A-500MM	MERKEZİ ÇEKMECE KİLİDİ	Merkezi gövde çubuğu 2,4 mm kalınlıkta, alüminyum malzemedir. 2 kırılabilir anahtar mevcuttur.
288-19A-600MM	CENTRAL DRAWER LOCK	The central body bar is 2.4 mm thick, aluminum material. 2 breakable keys are available.
288-19A-700MM	ZENTRALES SCHUBLADENSCHLOSS	Die zentrale Körperstange ist 2,4 mm dickes Aluminiummaterial. 2 abbrechbare Schlüssel sind vorhanden.

ÜRÜN TANIMI PRODUCT DESCRIPTION PRODUKTBESCHREIBUNG		ÜRÜN GÖRSELİ PRODUCT IMAGE PRODUKTBILD	TEKNİK ÇİZİM TECHNICAL DRAWING TECHNISCHE ZEICHNUNG
NO 138-22C	KARE ÇEKMECE KİLİDİ SQUARE DRAWER LOCK QUADRATISCHES SCHUBLADENSCHLOSS		
NO 106C	OVAL ÇEKMECE KİLİDİ OVAL DRAWER LOCK OVALES SCHUBLADENSCHLOSS		
NO 103-16	POSTA KUTUSU KİLİDİ MAILBOX LOCK BRIEFKASTENSCHLOSS		
NO 103-20			
NO 103-25			
288-19A-500MM	MERKEZİ ÇEKMECE KİLİDİ		
288-19A-600MM	CENTRAL DRAWER LOCK		
288-19A-700MM	ZENTRALES SCHUBLADENSCHLOSS		

TOPUZLU KARE ÇİFT KAPAK KİLİDİ

SQUARE DOUBLE DOOR LOCK WITH KNOB

QUADRATISCHES DOPPELTÜRSCHLOSS MIT KNOPF

Malzeme Material	Zamak Zamac	
Yüzey Auftauchen Surface	Krom Kaplama Chrome Plated Verchromt	
Silindir Çap ve Gövde Boyu Cylinder Diameter and Body Length Zylinderdurchmesser und Körperlänge	D 18mmx L22mm	
TEKNİK ÖLÇÜLERİ	TECHNICAL DIMENSIONS	TECHNISCHE ABMESSUNGEN

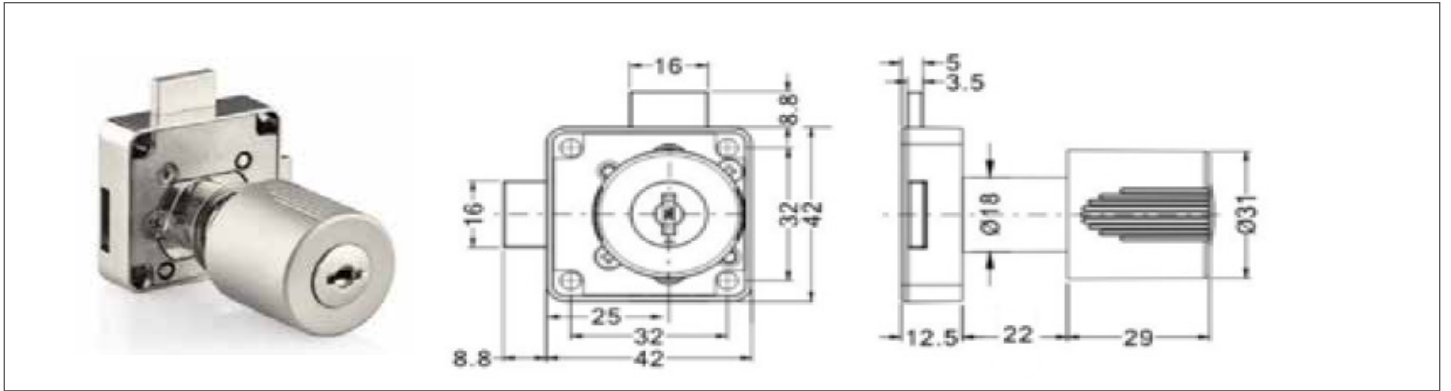

TOPUZLU İSPANYOLET KİLİT

SPANISH LOCK WITH KNOB

SPANISCHSCHLOSS MIT KNOPF

Malzeme Material	Zamak Zamac	
Yüzey Auftauchen Surface	Krom Kaplama Chrome Plated Verchromt	
Silindir Çap ve Gövde Boyu Cylinder Diameter and Body Length Zylinderdurchmesser und Körperlänge	D 18mmx L22mm	
TEKNİK ÖLÇÜLERİ	TECHNICAL DIMENSIONS	TECHNISCHE ABMESSUNGEN

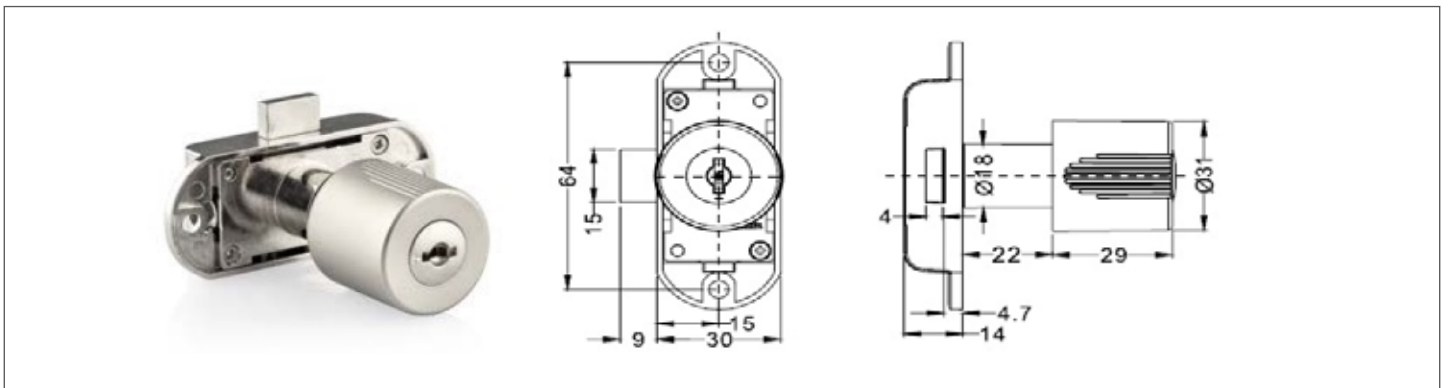

SİLİNDİRLİ GÖMME KİLİT *Rulmansız*

CYLINDER MIXED LOCK

ZYLINDER GEMISCHTES SCHLOSS

Gövde ve Karşılık Body and Striker Körper und Stürmer	Galvaniz kaplamalı çelik, Nikel kaplama Galvanized steel, Nickel plated Verzinkter Stahl, Vernickelt	
Sürgü Slide Gleiten	Zamak. Çinko kaplamalı. Zamak. Zinc plated. Zamak. Verzinkt.	
Mandal Latch Verriegeln	Zamak. Çinko kaplamalı. Zamak. Zinc plated. Zamak. Verzinkt.	
Yön Direction Richtung	Çevrilebilir Rotative Rotierend	
Sertifikalar Certificates Zertifikate	TS EN 12209.	
TEKNİK ÖLÇÜLERİ	TECHNICAL DIMENSIONS	TECHNISCHE ABMESSUNGEN

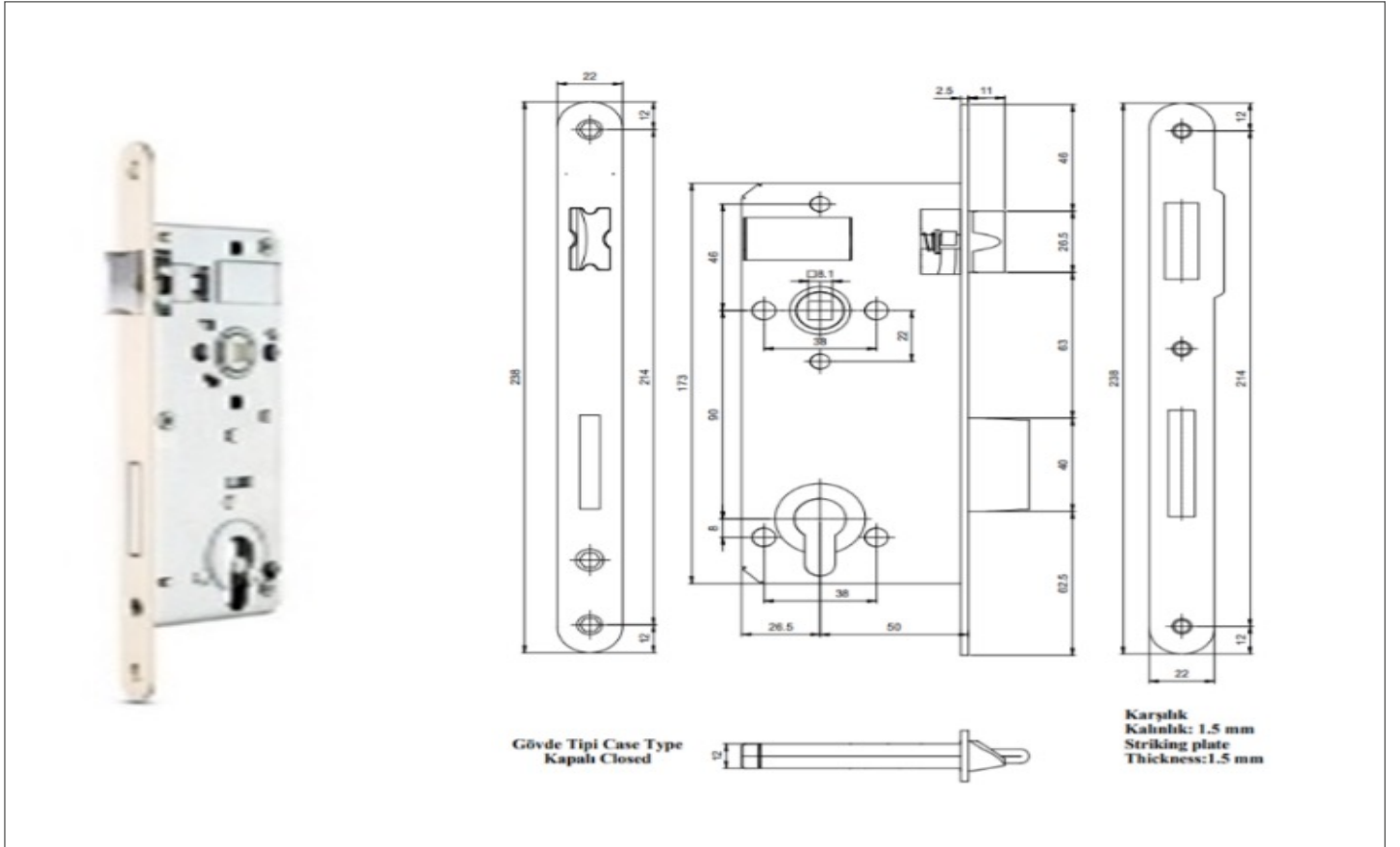

İÇ KAPI GÖMME KİLİT

INTERIOR DOOR MIXED LOCK

INNENTÜR GEMISCHTES SCHLOSS

Gövde ve Karşılık Body and Striker Körper und Stürmer	Galvaniz kaplamalı çelik, Krom kaplama Galvanized steel, Chrome plated Verzinkter Stahl, Verchromt	
Sürgü Slide Gleiten	Zamak döküm. Krom kaplamalı. Zamak casting. Chrome plated. Zamak-Guss. Verchromt.	
Mandal Latch Verriegeln	Zamak döküm. Krom kaplamalı. Zamak casting. Chrome plated. Zamak-Guss. Verchromt.	
Yön Direction Richtung	Çevrilebilir Rotative Rotierend	
Sertifikalar Certificates Zertifikate	TS EN 12209.	
TEKNİK ÖLÇÜLERİ	TECHNICAL DIMENSIONS	TECHNISCHE ABMESSUNGEN

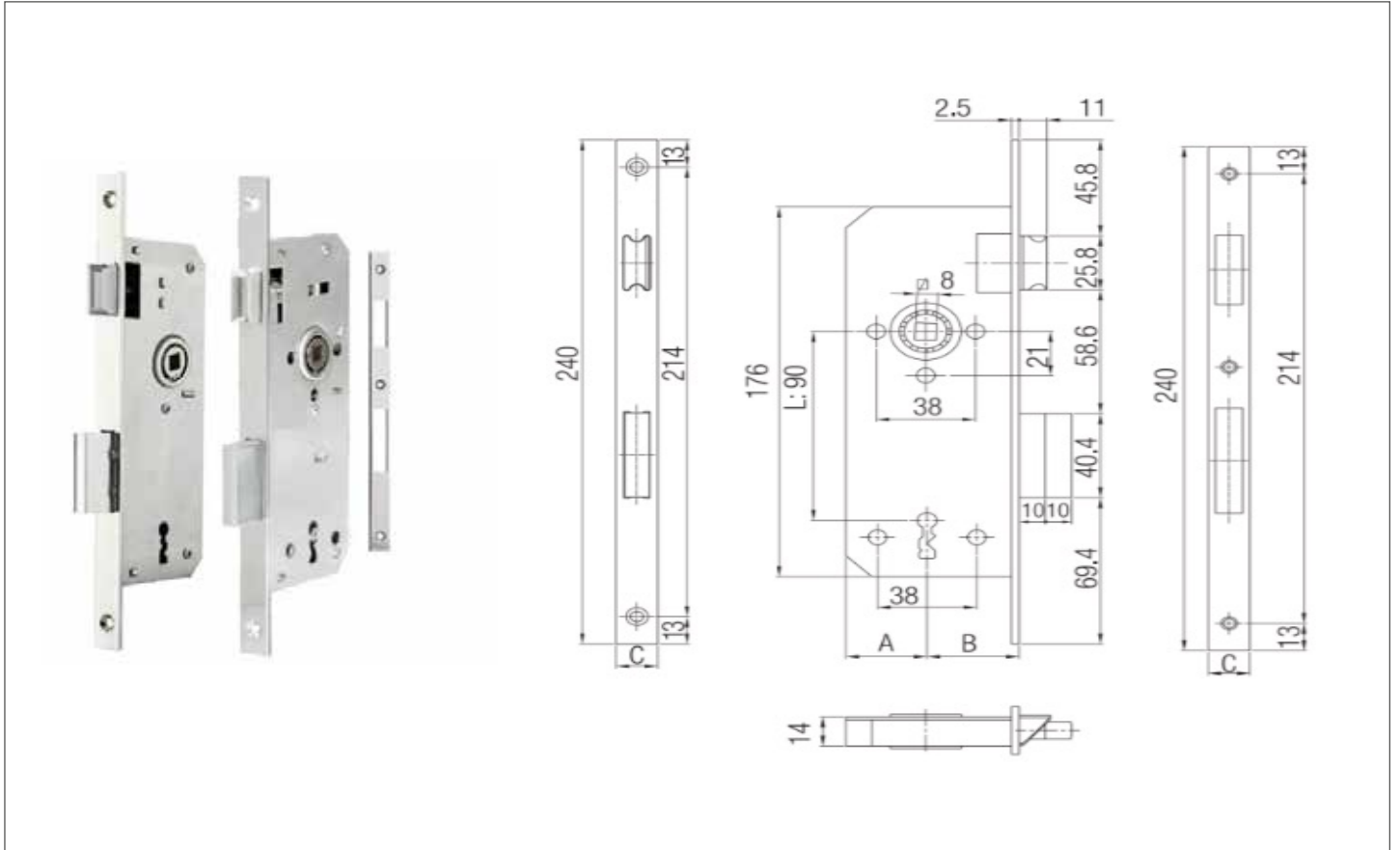

İÇ KAPI ODA/WC GÖMME KİLİTLER

INTERIOR DOOR ROOM/WC MIXED LOCKS

INNENTÜR ZIMMER/WC GEMISCHTE SCHLÖSSER

TEKNİK BİLGİLER TECHNICAL INFORMATION TECHNISCHE INFORMATION	ÜRÜN CİNSİ PRODUCT TYPE PRODUKTART	ÖLÇÜLER		DIMENSIONS		MASSE		AĞIRLIK(GR) WEIGHT(G) GEWICHT (G)
		a	b	c	d	e	f	
Galvaniz Gövde Galvanized Body Verzinkter Körper	35mm WC Kilidi Rulmanlı Nikel Nickel with 35mm WC Lock Bearing Nickel mit 35mm WC-Schlosslager	35	240	176	90	23	3	585
Krom Kaplamalı Ayna Chrome Plated Mirror Verchromter Spiegel	40mm WC Kilidi Rulmanlı Nikel Nickel with 40mm WC Lock Bearing Nickel mit 40mm WC-Schlosslager	40	240	176	85	23	3	545
Zamak Sürgü Zamak Bolt Zamak-Bolzen	35mm Oda Kilidi Rulmanlı Nikel Nickel with 35mm Chamber Lock Bearing Nickel mit 35mm Kammverriegelungslager	35	240	176	90	23	3	545
Zamak Krom Kaplamalı Mandal Zamak Chrome Plated Latch Verchromter Zamak-Riegel	40mm Oda Kilidi Rulmanlı Nikel Nickel with 40mm Chamber Lock Bearing Nickel mit 40mm Kammverriegelungslager	40	240	176	90	23	3	256

TEKNİK ÖLÇÜLERİ

TECHNICAL DIMENSIONS

TECHNISCHE ABMESSUNGEN

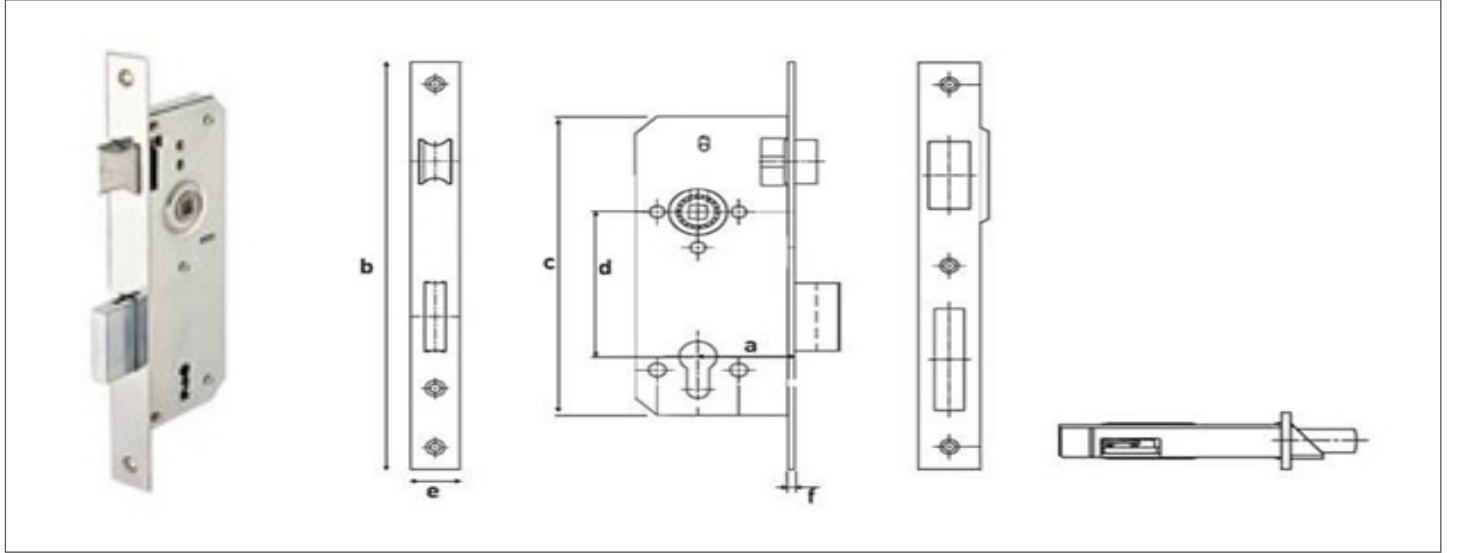

DIŐTAN TAKMA TİRAJLI KİLİT

OUTBOARD RIM LOCK

AUSSENLIEGENDES FELGENSCHLOSS

Gövde ve Karşılık Body and Striker Körper und Stürmer	Çelik. Elektrostatik siyah boyalı Steel. Electrostatic black painted Stahl. Elektrostatisch schwarz lackiert	
Sürgü Slide Gleiten	Çelik. Üç milli. Nikel kaplamalı Steel. Three national. Nickel plated Stahl. Drei national. Vernickelt	
Mandal Latch Verriegeln	Pirinç Brass Messing	
Silindir Cylinder Zylinder	Pirinç Brass Messing	
Rozet Rosette	Çelik Steel Stahl	
Yön Direction Richtung	Sağ veya sol Right or left Rechts oder links	
Sertifikalar Certificates Zertifikate	TS EN 12209	
TEKNİK ÖLÇÜLERİ	TECHNICAL DIMENSIONS	TECHNISCHE ABMESSUNGEN

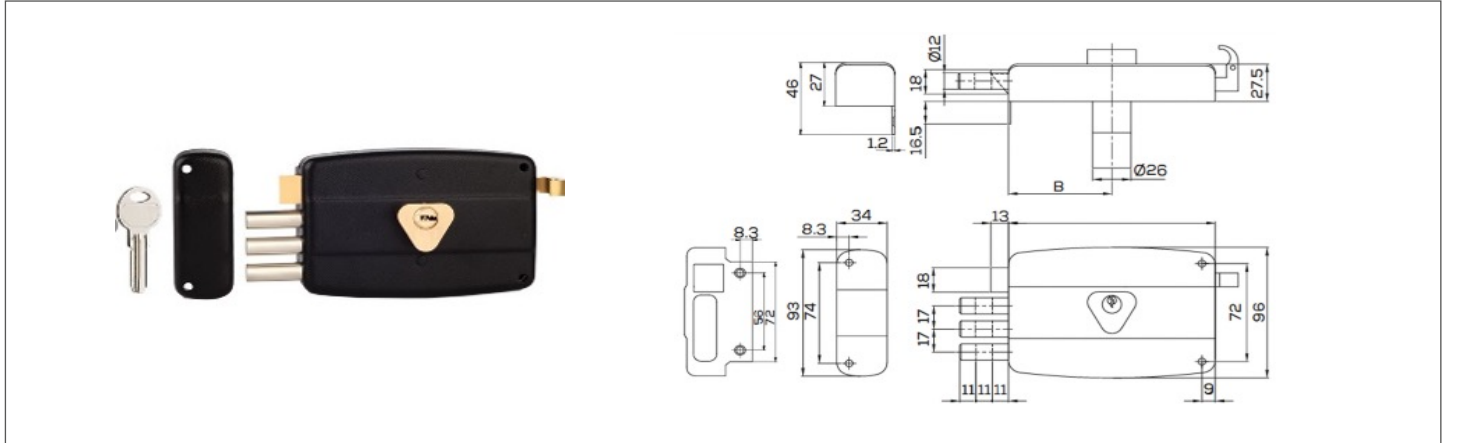

ELEKTRİKLİ KİLİT TİRAJLI

ELECTRIC LOCK THREAD

GEWINDE FÜR ELEKTRISCHES SCHLOSS

Gövde ve Karşılık Body and Striker Körper und Stürmer	Çelik. RAL 9007 Gri boyalı / RAL 9004 Siyah boyalı Steel. Painted RAL 9007 Gray / Painted RAL 9004 Black Stahl. Lackiert RAL 9007 Grau / Lackiert RAL 9004 Schwarz	
Sürgü Slide Gleiten	Pirinç Brass Messing	
Silindir Cylinder Zylinder	Pirinç Brass Messing	
Rozet Rosette	Çelik Steel Stahl	
Voltaj Aralığı Voltage Range Spannungsbereich	12-15V ~ /15 W.	
TEKNİK ÖLÇÜLERİ	TECHNICAL DIMENSIONS	TECHNISCHE ABMESSUNGEN

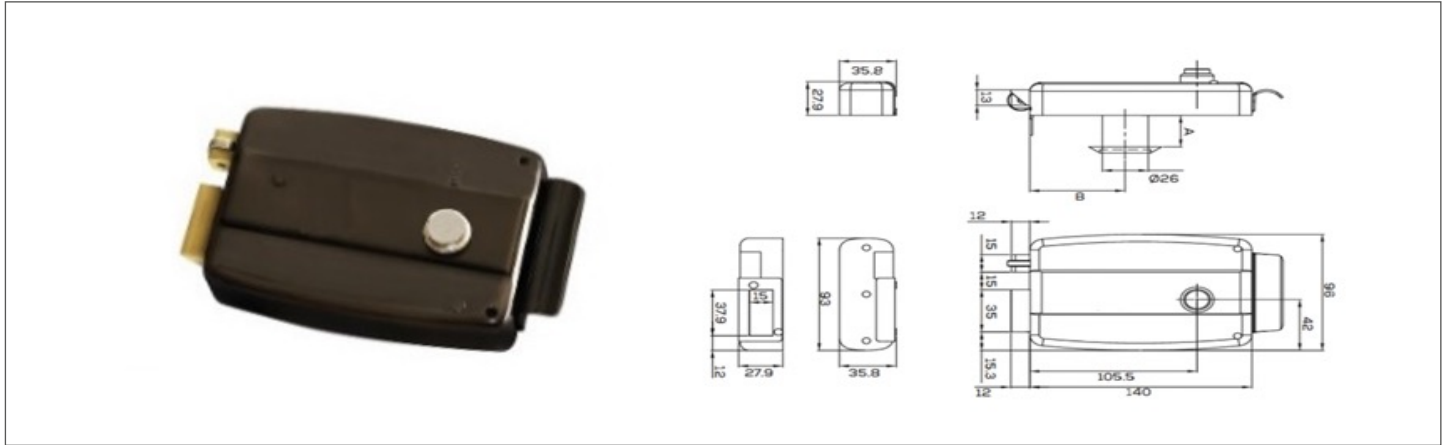

KARE TİRAJLI KİLİT

SQUARE ROUND LOCK

QUADRATISCHES RUNDSCHLOSS

Gövde ve Karşılık
Body and Striker
Körper und Stürmer

Elektrostatik Siyah veya Kırmızı Boyalı Sac
Electrostatic Black or Red Painted Sheet
Elektrostatisch schwarz oder rot lackiertes Blech

Sürgü
Slide
Gleiten

Pirinç
Brass
Messing

Silindir
Cylinder
Zylinder

Zamak
Zamac

TEKNİK ÖLÇÜLERİ

TECHNICAL DIMENSIONS

TECHNISCHE ABMESSUNGEN

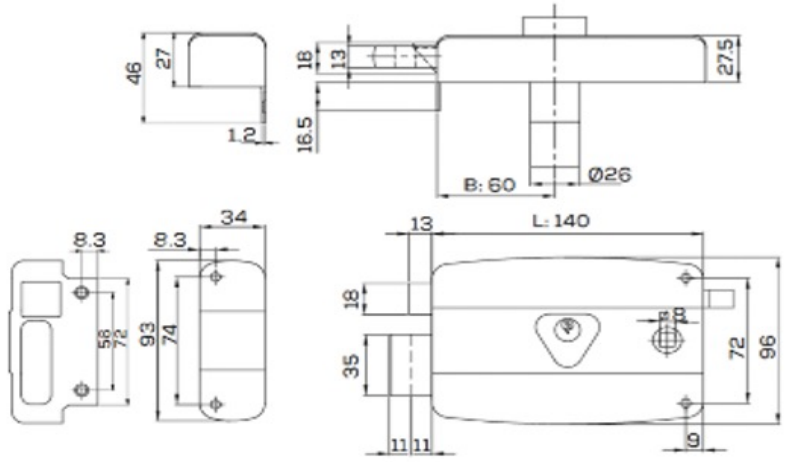

CAM KAPI KİLİTLERİ

GLASS DOOR LOCKS

GLASTÜRSCHLÖSSER

ÜRÜN ÇEŞİDİ PRODUCT TYPE PRODUKTART	KÜÇÜK KİLİT SMALL LOCK KLEINES SCHLOSS	BÜYÜK KİLİT BIG LOCK GROSSES SCHLOSS	KOLLU KİLİT SLEEVE LOCK HÜLSENSCHLOSS
AĞIRLIK WEIGHT GEWICHT	273 g	742 g	1600 g
MALZEME MATERIAL MATERIAL	SS201 KALİTE PASLANMAZ ÇELİK SS201 QUALITY STAINLESS STEEL EDELSTAHL DER QUALITÄT SS201		
YÜZEY AUFTAUCHEN SURFACE	MAT SATEN MATT SATIN		
ANAHTAR MALZEMESİ KEY MATERIAL SCHLÜSSEL MATERIAL	2 ADET PRİNÇ ANAHTARLI 2 PIECES OF BRASS KEY 2 STÜCKE MESSINGSCHLÜSSEL	3 ADET PRİNÇ ANAHTARLI 3 PIECES OF BRASS KEY 3 STÜCKE MESSINGSCHLÜSSEL	5 ADET PRİNÇ ANAHTARLI 5 PIECES OF BRASS KEY 5 STÜCKE MESSINGSCHLÜSSEL
DETAY DETAIL DETAIL	8MM-10MM ARASI KALINLIKTAKİ HEM CAMA UYUM SAĞLAYABİLİR. IT CAN ADAPT TO BOTH GLASS WITH A THICKNESS BETWEEN 8MM-10MM. ES KANN SICH AN BEIDE GLAS MIT EINER DICKE ZWISCHEN 8MM-10MM ANPASSEN.		
TEKNİK ÖLÇÜLERİ	TECHNICAL DIMENSIONS	TECHNISCHE ABMESSUNGEN	

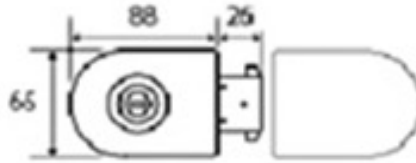
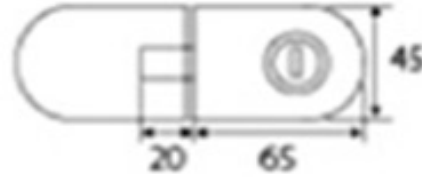

BAREL

CYLINDER

ZYLINDER

ÖLÇÜLERİ DIMENSIONS MASSE	63mm	83mm	90mm	100mm
AĞIRLIK (gram) WEIGHT (grams) GEWICHT (gramm)	172	190	220	250
MALZEME MATERIAL MATERIAL	ZAMAK ZAMAK			

TEKNİK ÇİZİM

TECHNICAL DRAWING

TECHNISCHE ZEICHNUNG



A	26	26	26	30	26	30	33	30	35	33	35	35	40	40	45
B	26	30	32	30	35	35	33	40	35	40	40	45	40	45	45
L	62	66	68	70	71	75	76	80	80	83	85	90	90	95	100

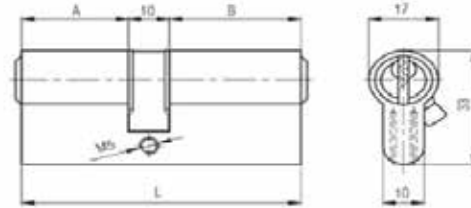

MENTEŞELER

HINGE

SCHARNIER

ÇEŞİTLERİ TYPES TYPEN	TAS MENTEŞE FLAT HINGE FLACHES SCHARNIER	PİSTONLU MENTEŞE HYDRAULIC HINGE KOLBENSCHARNIER FULL OVERLAY - HALF OVERLAY - INSET	DERECELİ MENTEŞE GRADE HINGE GRADE SCHARNIER 45° - 90° - 135° - 165°	DERECELİ PİSTONLU MENTEŞE GRADE HYDRAULIC HINGE GRADE KOLBENSCHARNIER 45° - 90° - 165°
AĞIRLIK (gram) WEIGHT (grams) GEWICHT (gramm)	62	93	45° 70 g 90° 72 gr 135° 88gr 165° 142gr	45° 106g 90° 106 g 165° 142g
MALZEME MATERIAL MATERIAL	ÇELİK, NİKEL KAPLI NICKEL PLATED STEEL VERNICKELTER STAHL			
YÜZEY AUFTAUCHEN SURFACE	SATEN NİKEL SATIN NICKEL SATIN NICKEL			

TEKNİK ÇİZİM

TECHNICAL DRAWING

TECHNISCHE ZEICHNUNG

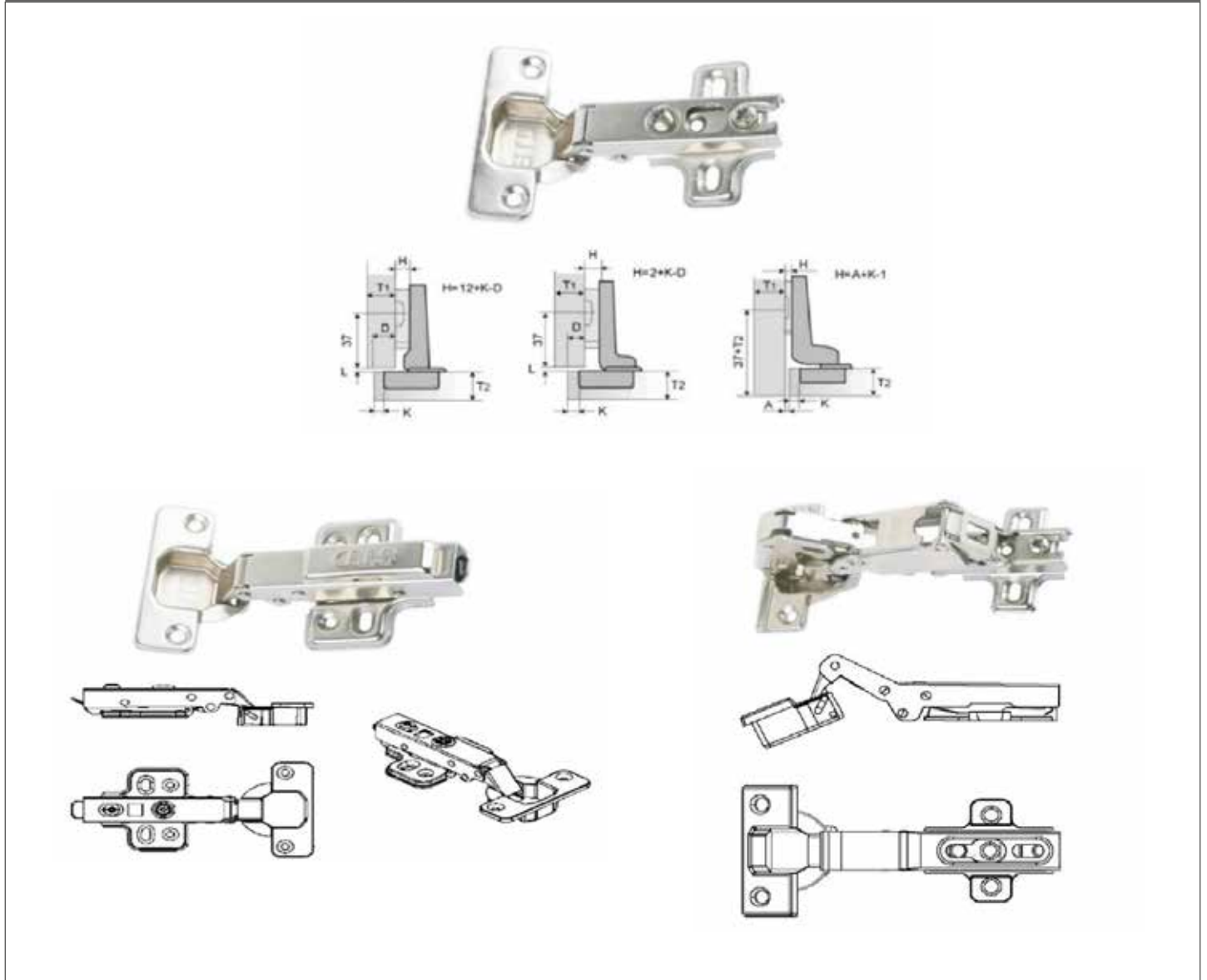

AÇILI MENTEŞE 35mm

ANGLE HINGE 35mm

WINKEL SCHARNIER 35mm



Teknik Özellikler	
Malzeme	Zamak
Kaplama	Nikel Kaplama
Ölçü	Ayarlı 35mm
Technical Specifications	
Material	Zamak
Covering	Nickel Plated
Measurement	Adjustable 35mm
Technische Daten	
Material	Zamak
Abdeckung	Vernickelt
Messung	Einstellbar 35 mm

AÇILI MENTEŞE GÖNYE BURUN

ANGLE HINGE MITER NOSE

WINKELSCHARNIER GEHRUNGSNASE



Teknik Özellikler	
Malzeme	Metal Sac ve Zamak
Kaplama	Nikel Kaplama
Ölçü	Ayarlı 35mm
Technical Specifications	
Material	Metal Sheet and Zamak
Covering	Nickel Plated
Measurement	Adjustable 35mm
Technische Daten	
Material	Blech und Zamak
Abdeckung	Vernickelt
Messung	Einstellbar 35 mm

TEKLİ MENTEŞE 270°

SINGLE HINGE 270°

EINZELSCHARNIER 270°



Teknik Özellikler	
Malzeme	Zamak
Kaplama	Nikel Kaplama
Açılma	270°
Technical Specifications	
Material	Zamak
Covering	Nickel Plated
Opening	270°
Technische Daten	
Material	Zamak
Abdeckung	Vernickelt
Öffnung	270°

MASA MENTEŞESİ 35mm

TABLE HINGE 35mm

TISCHSCHARNIER 35mm



Teknik Özellikler	
Malzeme	Zamak
Kaplama	Nikel Kaplama
Açılma	180°
Technical Specifications	
Material	Zamak
Covering	Nickel Plated
Opening	180°
Technische Daten	
Material	Zamak
Abdeckung	Vernickelt
Öffnung	180°

CAM KAPAK MENTEŞESİ

GLASS DOOR HINGE

GLASTÜRSCHARNIER



Teknik Özellikler

Malzeme	Sac Metal
Kaplama	Nikel Kaplama
Ayarlama	3 Yöne Ayarlanabilir
Ölçüler	Düz
	Deve Boynu
	Süper Deve Boynu

Technical Specifications

Material	Sheet Metal
Covering	Nickel Plated
Adjustment	3 Way Adjustable
Dimensions	Straight
	Camel neck
	Super Gooseneck

Technische Daten

Material	Blech
Abdeckung	Vernickelt
Einstellung	3-fach verstellbar
Maße	Gerade
	Kamelhals
	Super Schwanenhals

CAM KAPAK MENTEŞESİ 105°

GLASS DOOR HINGE 105°

GLASTÜRSCHARNIER 105°



Teknik Özellikler

Malzeme	Sac Metal
Kaplama	Nikel Kaplama
Ayarlama	3 Yöne Ayarlanabilir
Kapak Kalınlığı	14-22mm
Açı	105°
Ölçüler	Düz
	Deve Boynu
	Süper Deve Boynu

Technical Specifications

Material	Sheet Metal
Covering	Nickel Plated
Adjustment	3 Way Adjustable
Cover Thickness	14-22mm
Angle	105°
Dimensions	Straight
	Camel neck
	Super Gooseneck

Technische Daten

Material	Blech
Abdeckung	Vernickelt
Einstellung	3-fach verstellbar
Deckstärke	14-22mm
Winkel	105°
Maße	Gerade
	Kamelhals
	Super Schwanenhals

KAPI MENTEŞESİ

DOOR HINGE

TÜRANGEL



Technical Specifications

Material	Stainless steel
Top Surface	Satin Finish
Size	100 mm
Shaft Diameter	11,5 mm
Number of Bearings	4

Teknik Özellikler

Malzeme	Paslanmaz Çelik
Üst Yüzey	Saten Kaplama
Boy	100 mm
Mil Çapı	11,5 mm
Rulman Sayısı	4

Technische Daten

Material	Rostfreier Stahl
Obere Oberfläche	Satin-Finish
Größe	100 mm
Wellendurchmesser	11,5 mm
Anzahl der Lager	4

KAPI MENTEŞESİ

DOOR HINGE

TÜRANGEL

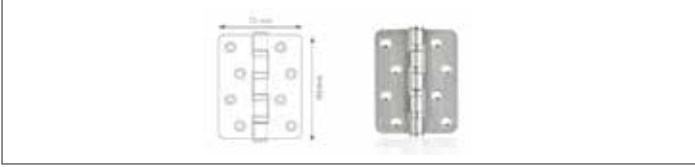

Technical Specifications

Material	Stainless steel
Top Surface	Satin Finish
Size	100 mm
Shaft Diameter	11,5 mm
Number of Bearings	4

Teknik Özellikler

Malzeme	Paslanmaz Çelik
Üst Yüzey	Saten Kaplama
Boy	100 mm
Mil Çapı	11,5 mm
Rulman Sayısı	4

Technische Daten

Material	Rostfreier Stahl
Obere Oberfläche	Satin-Finish
Größe	100 mm
Wellendurchmesser	11,5 mm
Anzahl der Lager	4

KAPI MENTEŞESİ

DOOR HINGE

TÜRANGEL



Technical Specifications

Material	Stainless steel
Top Surface	Satin Finish
Size	100 mm
Shaft Diameter	14 mm
Number of Bearings	3

Teknik Özellikler

Malzeme	Paslanmaz Çelik
Üst Yüzey	Saten Kaplama
Boy	100 mm
Mil Çapı	14 mm
Rulman Sayısı	3

Technische Daten

Material	Rostfreier Stahl
Obere Oberfläche	Satin-Finish
Größe	100 mm
Wellendurchmesser	14 mm
Anzahl der Lager	3

PARADUŞ MENTEŞE

SHOWER HINGE

DUSCHSCHARNIER

ÖLÇÜLERİ DIMENSIONS MASSE	90°	180°
AĞIRLIK WEIGHT GEWICHT	510 g	720 g
MALZEME MATERIAL MATERIAL	ZAMAK	
YÜZEY AUFTAUCHEN SURFACE	PARLAK NİKEL BRIGHT NICKEL GLÄNZENDES NICKEL	
DETAY DETAIL	8MM-10MM ARASI KALINLIKTAKİ HEM CAMA UYUM SAĞLAYABİLİR. IT CAN ADAPT TO BOTH GLASS WITH A THICKNESS BETWEEN 8MM-10MM. ES KANN SICH AN BEIDE GLAS MIT EINER DICKE ZWISCHEN 8MM-10MM ANPASSEN.	
TEKNİK ÖLÇÜLERİ	TECHNICAL DIMENSIONS	TECHNISCHE ABMESSUNGEN

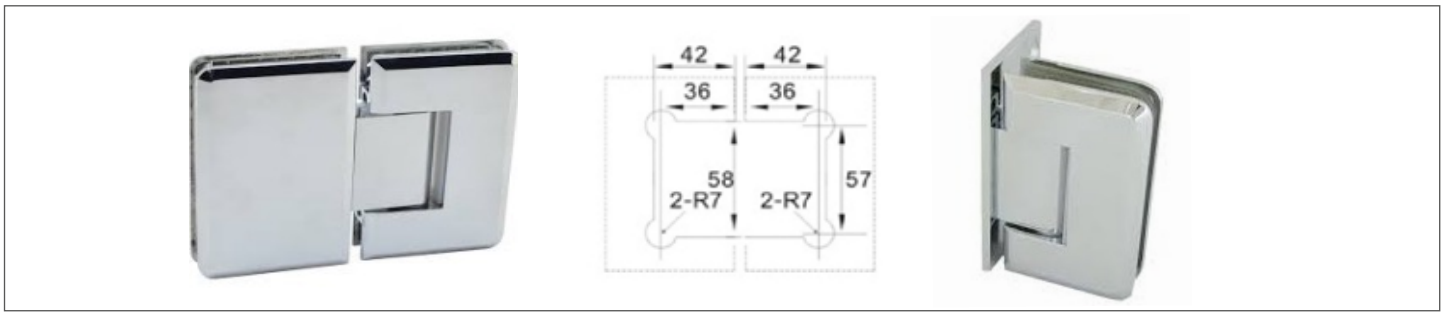

KAPI EMNİYET KELEPÇESİ

DOOR SAFETY CLAMP

TÜRSICHERUNGSKLAMMER

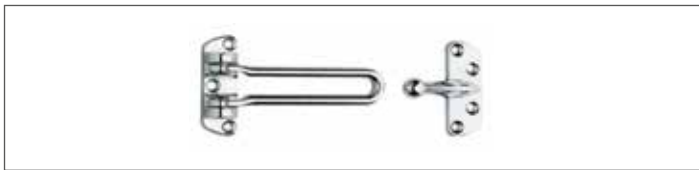

Technical Specifications	
Material	Special alloy zamak casting
Alternatives	Satin, Chrome, Brass Plated
Usage Area	Wooden, Metal and Steel Doors

Teknik Özellikler	
Malzeme	Özel alaşımli zamak döküm
Alternatifleri	Satin, Krom, Prınç Kaplama
Kullanım Alanı	Ahşap, Metal ve Çelik Kapılar

Technische Daten	
Material	Zamak-Guss aus Speziallegierung
Alternativen	Satin, Chrom, vermessingt
Einsatzbereich	Türen aus Holz, Metall und Stahl

GAZLI PİSTON

GAS SPRING

GASKOLBEN

ÇEŞİTLERİ TYPES TYPEN	80N	100N	120N	KISA SHORT KURZ			TERS AÇILIR DOWN OPEN UNTEN ÖFFNEN	YAVAŞ KAPANAN SOFT CLOSING SANFTES SCHLIEßEN	
				60N	80N	100N	100N	80N	100N
AĞIRLIK (gram) WEIGHT (grams) GEWICHT (gramm)	130	130	130	100	100	100	100	150	150
RENK COLOUR FARBE	GRİ- BEYAZ GREY- WHITE GRAU- WEISS	GRİ- BEYAZ GREY- WHITE GRAU- WEISS	GRİ GREY GRAU	GRİ GREY GRAU	GRİ GREY GRAU	GRİ GREY GRAU	GRİ GREY GRAU	GRİ GREY GRAU	GRİ GREY GRAU
UZUNLUK LENGTH LÄNGE	270 mm	270 mm	270 mm	230 mm	230 mm	230 mm	270 mm	270 mm	270 mm
TAŞIMA KAPASİTELERİ CARRYING CAPACITIES TRAGKAPAZİTÄTEN	4 KG	8 KG	10 KG	4 KG	6 KG	8 KG	8 KG	6 KG	8 KG
MALZEME MATERIAL MATERIAL	ÇELİK GÖVDE. PİRİNÇ YÜZÜK. STEEL BODY. BRASS RING. STAHLKÖRPER. MESSINGRING.								

TEKNİK ÖZELLİKLER

TECHNICAL SPECIFICATIONS

TECHNISCHE DATEN

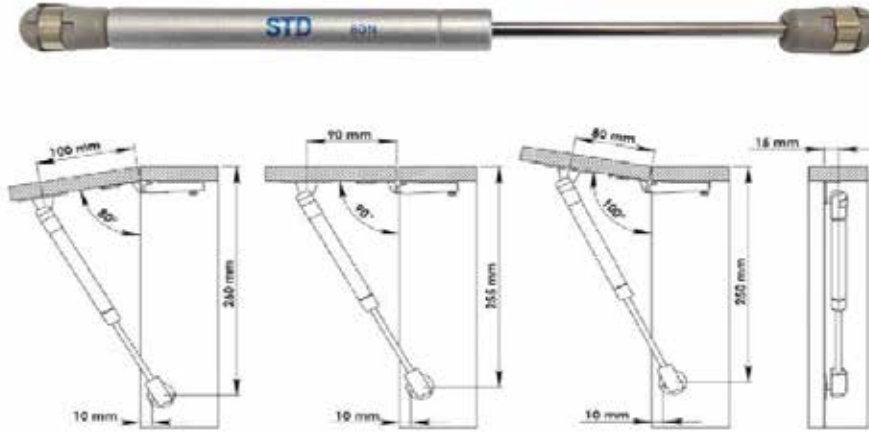

ÇEKMECE RAYLARI

DRAWER SLIDES

SCHUBLADENSCHIENEN

GENİŞLİK WIDTH BREITE	17mm				35mm					43mm				
UZUNLUK LENGTH LÄNGE	310mm	342mm	406mm	438mm	300mm	350mm	400mm	450mm	500mm	300mm	350mm	400mm	450mm	500mm
AĞIRLIK (grams) WEIGHT (grams) GEWICHT(grams)	230	250	275	330	615	785	900	1020	1150	860	1030	1160	1320	1460
MALZEME MATERIAL MATERIAL	DX51 B YÜZEY GALVANİZ SAC DX51 B SURFACE GALVANIZED SHEET DX51 B OBERFLÄCHE VERZINKTES BLECH													
YÜZEY AUFTAUCHEN SURFACE	KAPLAMASIZ UNCOATED UNBESCHICHTET													

TEKNİK ÇİZİM

TECHNICAL DRAWING

TECHNISCHE ZEICHNUNG

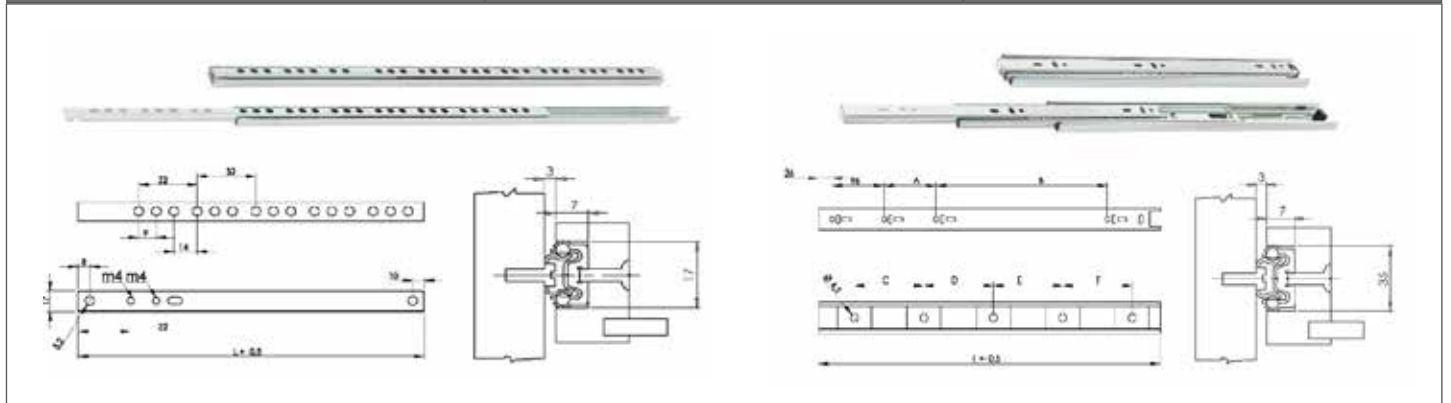

KAPAK İTİCİ

PUSH OPEN

AUFSTOSSEN

ÇEŞİTLERİ TYPES TYPEN	STD 001 BEYAZ STD 001 WHITE STD 001 WEISS	STD 001 GRİ STD 001 GREY STD 001 GRAU	STD 002 SATEN STD 002 SATIN
ÜRÜN GÖRSELİ PRODUCT IMAGE PRODUKTBILD			
AĞIRLIK (gram) WEIGHT (grams) GEWICHT (gramm)	170	170	248
UZUNLUK LENGTH LÄNGE	130 mm	130 mm	118 mm
YÜZEY AUFTAUCHEN SURFACE	PLASTİK PLASTIC PLASTIK	PLASTİK PLASTIC PLASTIK	PASLANMAZ ÇELİK STAINLESS STEEL ROSTFREIER STAHL

KAPI KOLU

DOOR HANDLE

TÜRSCHNALLE

MODEL ADI MODEL NAME MODELLNAME	ECEM	SS01	SS02
ÇEŞİTLERİ TYPES TYPEN	ODA, YALE, WC ROOM, YALE, WC ZIMMER, YALE, WC	ODA, YALE, WC ROOM, YALE, WC ZIMMER, YALE, WC	ODA, YALE, WC ROOM, YALE, WC ZIMMER, YALE, WC
MALZEME MATERIAL MATERIAL	ALUMİNYUM ALUMINUM ALUMINIUM	PASLANMAZ 304 STAINLESS 304 EDELSTAHL 304	PASLANMAZ 201 STAINLESS 201 EDELSTAHL 201
AĞIRLIK (gram) WEIGHT (grams) GEWICHT (gramm)	330	280	290
YÜZEY AUFTAUCHEN SURFACE	NİKEL NICKEL	SATEN SATIN	SATEN SATIN



CAM KAPI KOLU

GLASS DOOR HANDLE

TÜRGRIF F AUS GLAS

ÖLÇÜLERİ DIMENSIONS MASSE	30 cm	40 cm
AĞIRLIK WEIGHT GEWICHT	1075 g	1075 g
MALZEME MATERIAL MATERIAL	SS201 KALİTE PASLANMAZ ÇELİK SS201 QUALITY STAINLESS STEEL EDELSTAHL DER QUALITÄT SS201	
YÜZEY AUFTAUCHEN SURFACE	PARLAK VEYA MAT GLOSSY OR MATTE GLÄNZEND ODER MATT	
TEKNİK ÖLÇÜLERİ	TECHNICAL DIMENSIONS	TECHNISCHE ABMESSUNGEN

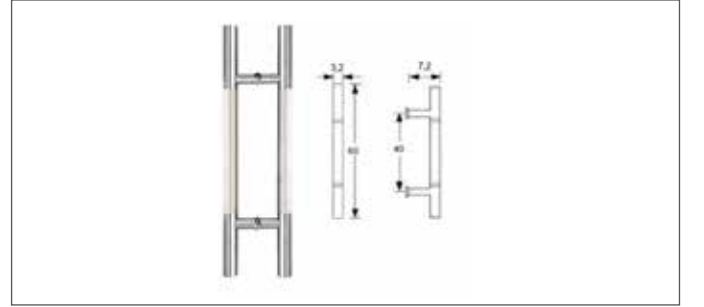
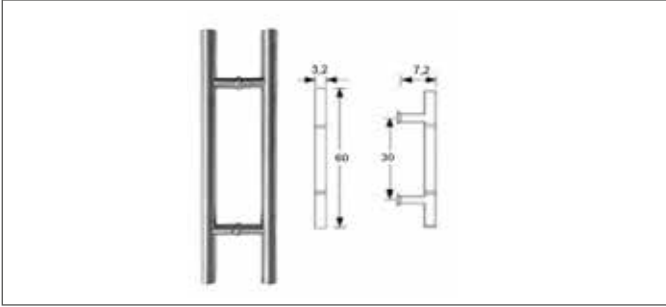

KİLİTLİ PENCERE KOLU

LOCKED WINDOW HANDLE

VERSCHLOSSENER FENSTERGRIF

ÇEŞİTLERİ TYPES TYPEN	TEKLİ KOLLAR SINGLE ARM EINZELARM	ÇİFTLİ KOLLAR DOUBLE ARM DOPPELARM		
AĞIRLIK (gram) WEIGHT (grams) GEWICHT (gramm)	205	375		
MALZEME MATERIAL MATERIAL	TABAN ZAMAK, KOL VE KAPLAMA ALÜMİNYUM BASE ZAMAK, HANDLE AND COATING ALUMINUM UNTERGESTELL ZAMAK, GRIFF UND BESCHICHTUNG ALUMINIUM	ALÜMİNYUM ALUMINUM ALLES ALUMINIUM		
RENK COLOUR FARBE	BEYAZ WHITE WEISS	SİYAH BLACK SCHWARZ	GÜMÜŞ GRİ SILVER GREY SILBER-GRAU	ANTRASİT ANTHRACITE ANTHRAZITGRAU
	RAL9016	RAL 9005	RAL 7001	RAL 7016



KAPI HİDROLİĞİ

DOOR CLOSER

TÜRSCHLISSER

ÇEŞİTLERİ TYPES TYPEN	(NO-3) 40-65 KG	(NO-4) 60-85 KG
AĞIRLIK (gram) WEIGHT (grams) GEWICHT (gramm)	2200	2500
MALZEME MATERIAL MATERIAL	ALÜMİNYUM GÖVDE + ÇELİK AKSESUAR ALUMINUM BODY + STEEL ACCESSORIES ALUMINIUMGEHÄUSE + STAHLZUBEHÖR	
YÜZEY AUFTAUCHEN SURFACE	MAT SATEN MATT SATIN MATT SATIN	MAT SATEN MATT SATIN MATT SATIN
DETAY DETAIL DETAIL	3 YIL GARANTİLİDİR. GUARANTEED FOR 3 YEARS. 3 JAHRE GARANTIE.	
	SAĞ VE SOL KULLANIMA UYGUNDUR. SUITABLE FOR RIGHT AND LEFT USE. GEEIGNET FÜR DEN RECHTEN UND DEN LINKEN GEBRAUCH.	
	KAPANMA HIZI AYARLANABİLİR. CLOSE SPEED CAN BE ADJUSTED. SCHLIEßGESCHWINDIGKEIT KANN EINGESTELLT WERDEN.	
KULLANIM AMACI PURPOSE OF USAGE NUTZUNGSZWECK	BU ÜRÜNÜN ANA GÖREVİ KAPIYI KAPATMAKTIR ANCAK KAPANMA POZİSYONUNA YAKLAŞTIĞINDA KAPIYI YAVAŞLATMAK VE KAPININ YUMUŞAK KAPANMASINI SAĞLAMAK İÇİN DE KULLANILMAKTADIR.	
	THE MAIN DUTY OF THIS PRODUCT IS TO CLOSE THE DOOR, BUT IT IS ALSO USED TO SLOW THE DOOR TO SLOW UP AND PROVIDE SOFT CLOSING OF THE DOOR WHEN IT CLOSE TO THE CLOSING POSITION.	
	DIE HAUPTAUFGABE DIESER PRODUKTS IST DAS SCHLIESSEN DER TÜR, ABER ES WIRD AUCH VERWENDET, UM DIE TÜR ZU VERLANGSAMEN UND EIN SANFTES SCHLIESSEN DER TÜR ZU GEWÄHRLEISTEN, WENN SIE SICH DER GESCHLOSSENEN POSITION NAHE.	

TEKNİK ÇİZİM

TECHNICAL DRAWING

TECHNISCHE ZEICHNUNG

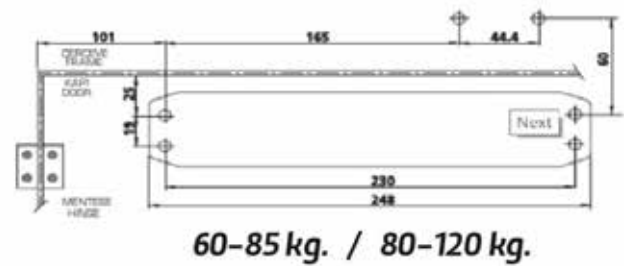
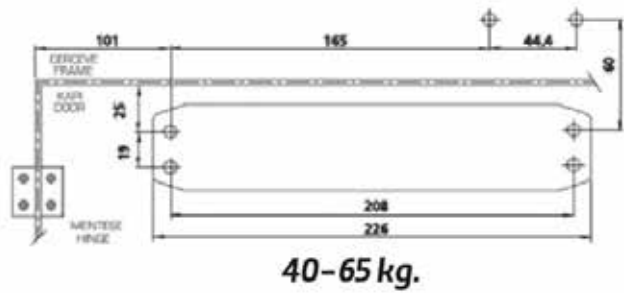

KAPI STOPERİ

DOOR STOPPER

TÜRSTOPPER

Ürün Özellikleri	Product Properties	Produkt Eigenschaften
	Malzeme Material	Paslanmaz Çelik Stainless steel Rostfreier Stahl
	Renk Colour Farbe	Mat Matte
	Uzunluk Length Länge	35 mm
	Çap Kesit Ölçüsü Diameter Section Dimension Durchmesser Abschnitt Dimension	29 mm
	Dış Yükseklik Outside Height Außenhöhe	40 mm

KAPI DÜRBÜNÜ

DOOR VIEWER

TÜRSPIEGEL

Ürün Özellikleri	Product Properties	Produkt Eigenschaften
Malzeme Material	Çelik Steel Stahl	
Renk Colour Farbe	SATEN SATIN	
Uzunluk Length Länge	60M-90MM	
Görüş açısı Visual angle Sichtwinkel	180°	
Çap Diameter Durchmesser	25 mm	

GARDROP SÜRGÜ MEKANİZMASI

WARDROBE SLIDING MECHANISM

GARDEROBE-SCHIEBEMECHANISMUS

AĞIRLIK (gram) WEIGHT (grams) GEWICHT (gramm)	120 g
TAŞIMA KAPASİTESİ CARRYING CAPACITIES TRAGKAPAZITÄTEN	80 kg
MALZEME MATERIAL MATERIAL	PLASTİK + DKP SAC PLASTIC + DKP SHEET KUNSTSTOFF + DKP BLATT

TEKNİK ÇİZİM

TECHNICAL DRAWING

TECHNISCHE ZEICHNUNG

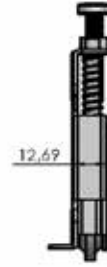
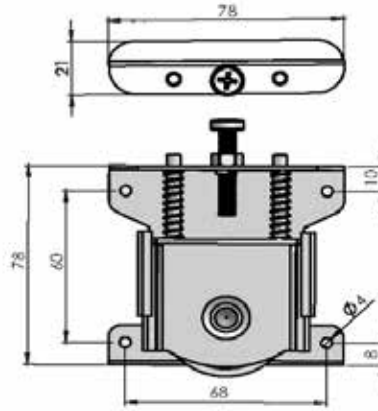

DOLAP ASKI ELEMANI

CABINET HANGER

SCHRANKAUFHÄNGER

MALZEME MATERIAL MATERIAL	PLASTİK + DKP SAC PLASTIC + DKP SHEET KUNSTSTOFF + DKP BLATT	
RENK COLOUR FARBE	BEYAZ WHITE WEISS	
SAC KALINLIĞI THICKNESS DICKE	1,20M	
TAŞIMA KAPASİTESİ CARRYING CAPACITIES TRAGKAPAZITÄTEN	80 KG	

BİTS UÇLAR

BITS INSERTS

BITS-EINSÄTZE

ÖLÇÜLERİ DIMENSIONS MASSE	25mm	50mm	75mm	100mm	150mm	T 30X50	T 30X75	T 30X100
ÇEŞİTLERİ TYPES TYPEN	PZ, PH	PZ, PH	PZ, PH	PZ, PH	PZ, PH	TORX	TORX	TORX
MALZEME MATERIAL MATERIAL	CRV MANTEYİK CRV MAGNETIC CRV MAGNETISCH	CRV MANTEYİK CRV MAGNETIC CRV MAGNETISCH	CRV MANTEYİK CRV MAGNETIC CRV MAGNETISCH	CRV MANTEYİK CRV MAGNETIC CRV MAGNETISCH	CRV MANTEYİK CRV MAGNETIC CRV MAGNETISCH	CRV MANTEYİK CRV MAGNETIC CRV MAGNETISCH	CRV MANTEYİK CRV MAGNETIC CRV MAGNETISCH	CRV MANTEYİK CRV MAGNETIC CRV MAGNETISCH
YÜZEY AUFTAUCHEN SURFACE	KUMLANMIŞ BLASTED GESPRENGT	KUMLANMIŞ BLASTED GESPRENGT	KUMLANMIŞ BLASTED GESPRENGT	KUMLANMIŞ BLASTED GESPRENGT	KUMLANMIŞ BLASTED GESPRENGT	KUMLANMIŞ BLASTED GESPRENGT	KUMLANMIŞ BLASTED GESPRENGT	KUMLANMIŞ BLASTED GESPRENGT

TEKNİK ÖLÇÜLERİ

TECHNICAL DIMENSIONS

TECHNISCHE ABMESSUNGEN

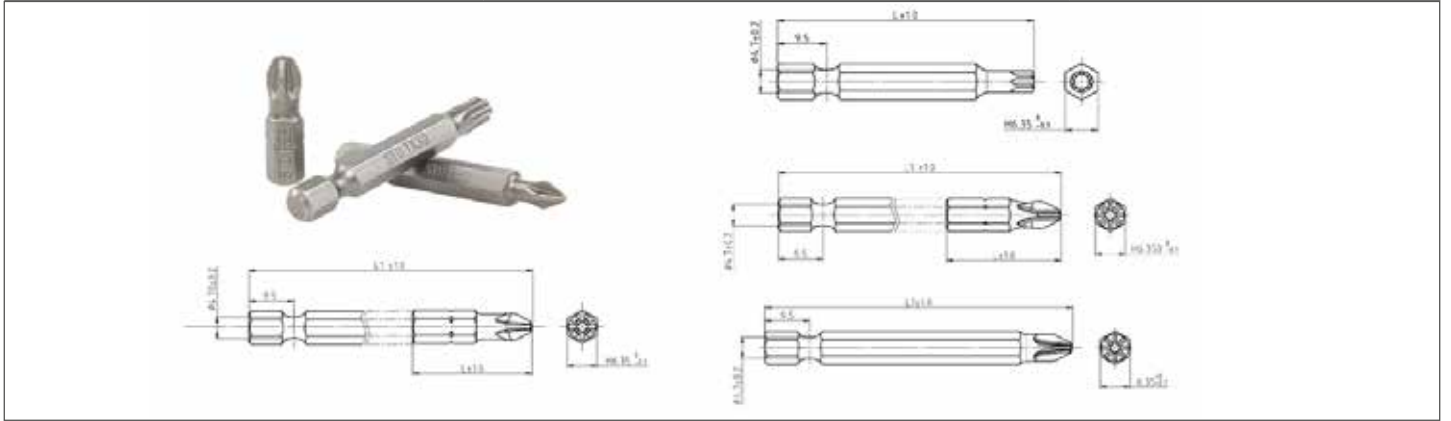

SOMUN ADAPTÖRLERİ

NUT ADAPTERS

MUTTERN-ADAPTER

ÖLÇÜLERİ DIMENSIONS MASSE	8mm*45mm	8mm*65mm	10mm*45mm	10mm*65mm	Uzatma Adaptör 60mm Extension Adapter 60mm Verlängerungsadapter 60mm
MALZEME MATERIAL MATERIAL	CRV / MANTEYİK CRV / MAGNETIC CRV / MAGNETISCH	CRV / MANTEYİK CRV / MAGNETIC CRV / MAGNETISCH	CRV / MANTEYİK CRV / MAGNETIC CRV / MAGNETISCH	CRV / MANTEYİK CRV / MAGNETIC CRV / MAGNETISCH	CRV / MANTEYİK CRV / MAGNETIC CRV / MAGNETISCH
YÜZEY AUFTAUCHEN SURFACE	KUMLANMIŞ BLASTED GESPRENGT	KUMLANMIŞ BLASTED GESPRENGT	KUMLANMIŞ BLASTED GESPRENGT	KUMLANMIŞ BLASTED GESPRENGT	KUMLANMIŞ BLASTED GESPRENGT

TEKNİK ÖLÇÜLERİ

TECHNICAL DIMENSIONS

TECHNISCHE ABMESSUNGEN

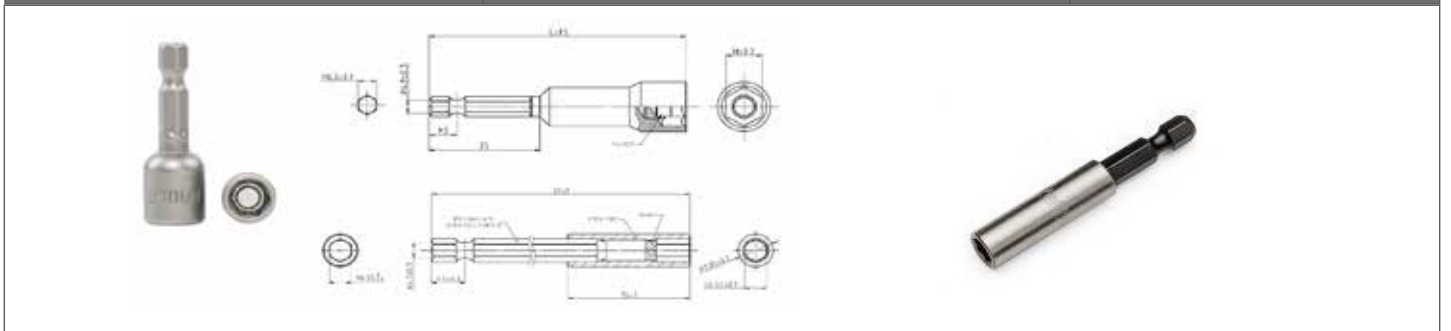

ALLEN ANAHTAR

ALLEN KEY

INBUSSCHLÜSSEL



ÖLÇÜLERİ DIMENSIONS MASSE	1,5 MM	2 MM	2,5 MM	3 MM	4 MM	5 MM	6 MM	8 MM
MALZEME MATERIAL MATERIAL	Otomat Çeliği Cutting Steel Schneiden Von Stahl			KULLANIM USAGE NUTZUNGSZWECK				
				<p>Altıgen profili olan ve içeri gömük vidaları, imbus başlı cıvataları sökmeye yarayan anahtar çeşididir.</p> <p>It is a type of wrench that has a hexagonal profile and is used to remove recessed screws and imbus head bolts.</p> <p>Es handelt sich um eine Art Schraubenschlüssel mit Sechskantprofil, der zum Entfernen von Kreuzschlitzschrauben und Imbuskopfschrauben verwendet wird.</p>				

PVC TEZGAH ALTI EVYE ÖRTÜSÜ

PVC DECORATIVE FILM

PVC-ZIERFOLIE

AĞIRLIK (gram/m ²) WEIGHT (grams/m ²) GEWICHT (gramm/m ²)	195 GR / M2		
RENK COLOUR FARBE	GÜMÜŞ SILVER SILBER		
MALZEME MATERIAL	MALZEME HAMMADESİ PVC KAPLI ALUMINYUM FİLMİDİR. MATERIAL RAW MATERIAL IS PVC COATED ALUMINUM FILM. MATERIAL ROHSTOFF IST PVC-BESCHICHTETE ALUMINIUMFOLIE.		
RULO ROLL ROLLEN	EN/ WIDTH/ BREITE	BOY/ LENGTH/ LÄNGE	AĞIRLIK/ WEIGHT/ GEWICHT
	120 cm	50 cm	11,70 kg
KULLANIM AMACI	<p>Alüminyum folyo kaplı PVC tezgah altı evye örtüsü özellikle raf ve dolap içlerinde ayrıca da tezgah üstünde kullanmak için tasarlanmıştır. Kendinden yapışkanlıdır. Su ve yağ geçirmez, kolay temizlenir. Tırtıklı deseni sayesinde kaymayı engelleyici üst yüzeye sahiptir.</p> <p>Aluminum foil-coated PVC undercounter sink cover is especially designed for use in shelves and cabinets, as well as on countertops. It is self adhesive. Water and oil proof, easy to clean. It has an anti-slip upper surface thanks to its serrated pattern.</p> <p>Die mit Aluminiumfolie beschichtete PVC-Unterbauspülenabdeckung ist speziell für den Einsatz in Regalen und Schränken sowie auf Arbeitsplatten konzipiert. Es ist selbstklebend. Wasser- und ölbeständig, leicht zu reinigen. Dank seines gezackten Musters hat es eine rutschfeste Oberfläche.</p>		

STD HALAT BAĞLANTI ELEMANLARI

RIGGING

TAKELWERK

ÜRÜN TANIMI PRODUCT DESCRIPTION PRODUKTBESCHREIBUNG	GERDİRME/ ÇEKTİRME TURNBUCKLE SPANNSCHLOSS							
ÜRÜN GÖRSELİ PRODUCT IMAGE PRODUKTBILD								
MALZEME MATERIAL MATERIAL	Q235B							
KAPLAMA COVERING ABDECKUNG	ELEKTRO GALVANİZ							
ÖLÇÜLERİ DIMENSIONS MASSE	M6	M8	M10	M12	M16	M20	M22	M24
AĞIRLIK (gram) WEIGHT (grams) GEWICHT (gramm)	52	95	165	275	655	1200	1700	2200

STD HALAT BAĞLANTI ELEMANLARI

RIGGING



TAKELWERK

ÜRÜN TANIMI PRODUCT DESCRIPTION PRODUKTBESCHREIBUNG	ZİNCİR KİLİDİ EUROPEAN TYPE SHACKLE EUROPÄISCHER TYP SCHÄKEL							
ÜRÜN GÖRSELİ PRODUCT IMAGE PRODUKTBILD								
MALZEME MATERIAL MATERIAL	Q235B							
KAPLAMA COVERING ABDECKUNG	ELEKTRO GALVANİZ							
ÖLÇÜLERİ DIMENSIONS MASSE	M6	M8	M10	M12	M16	M20	M22	M24
AĞIRLIK (gram) WEIGHT (grams) GEWICHT (gramm)	22	48	88	170	400	780	1100	1650

STD HALAT BAĞLANTI ELEMANLARI

RIGGING									TAKELWERK							
ÜRÜN TANIMI PRODUCT DESCRIPTION PRODUKTBESCHREIBUNG	A TİPİ KLEMENS A-TYPE WIRE ROPE CLIP DRAHTSEILKLEMME TYP A								KLEMENS WIRE ROPE CLIP DRAHTSEILKLEMME							
ÜRÜN GÖRSELİ PRODUCT IMAGE PRODUKTBILD																
MALZEME MATERIAL	Q235B								Q235B							
KAPLAMA COVERING ABDECKUNG	ELEKTRO GALVANİZ								ELEKTRO GALVANİZ							
ÖLÇÜLERİ DIMENSIONS MASSE	M6	M8	M10	M12	M15	M18	M20	M22	M6	M8	M10	M12	M14	M16	M19	M22
AĞIRLIK (gram) WEIGHT (grams) GEWICHT (gramm)	20	30	65	130	208	270	395	575	14,7	26	52	105	120	170	220	340

STD HALAT BAĞLANTI ELEMANLARI

RIGGING								TAKELWERK					
ÜRÜN TANIMI PRODUCT DESCRIPTION PRODUKTBESCHREIBUNG	KARABİNA SPRING SNAP HOOK FEDERKARABINERHAKEN						VİDALI KARABİNA SPRING SNAP HOOK WITH SCREW FEDERKARABINERHAKEN MIT SCHRAUBE						
ÜRÜN GÖRSELİ PRODUCT IMAGE PRODUKTBILD													
MALZEME MATERIAL	Q195						Q195						
KAPLAMA COVERING ABDECKUNG	ELEKTRO GALVANİZ						ELEKTRO GALVANİZ						
ÖLÇÜLERİ DIMENSIONS MASSE	M5	M6	M7	M8	M10	M11	M12	M5	M6	M8	M10	M11	M12
AĞIRLIK (gram) WEIGHT (grams) GEWICHT (gramm)	14,5	25,5	41	60	120	175	246	16,5	28	64	124	180	254

STD HALAT BAĞLANTI ELEMANLARI

RIGGING

TAKELWERK

ÜRÜN TANIMI PRODUCT DESCRIPTION PRODUKTBESCHREIBUNG	ERKEK AYBOLT EYE BOLT RINGSCHRAUBE													
ÜRÜN GÖRSELİ PRODUCT IMAGE PRODUKTBILD														
MALZEME MATERIAL	Q235B													
KAPLAMA COVERING ABDECKUNG	ELEKTRO GALVANİZ													
ÖLÇÜLERİ DIMENSIONS MASSE	M6	M8	M10	M12	M14	M16	M18	M20	M22	M24	M27	M30	M33	M36
AĞIRLIK (gram) WEIGHT (grams) GEWICHT (gramm)	60	60	115	180	180	290	290	430	430	880	880	1650	1650	2600

STD HALAT BAĞLANTI ELEMANLARI

RIGGING

TAKELWERK

ÜRÜN TANIMI PRODUCT DESCRIPTION PRODUKTBESCHREIBUNG	DİŞİ AYBOLT EYE NUT AUGENMUTTER													
ÜRÜN GÖRSELİ PRODUCT IMAGE PRODUKTBILD														
MALZEME MATERIAL	Q235B													
KAPLAMA COVERING ABDECKUNG	ELEKTRO GALVANİZ													
ÖLÇÜLERİ DIMENSIONS MASSE	M6	M8	M10	M12	M14	M16	M18	M20	M22	M24	M27	M30	M33	M36
AĞIRLIK (gram) WEIGHT (grams) GEWICHT (gramm)	55	55	85	150	150	250	250	340	485	740	700	1400	1400	2200

PROFESYONEL MAKET BIÇAĞI METAL GÖVDE

PROFESSIONAL UTILITY KNIFE METAL BODY

PROFESSIONELLES GEBRAUCHSMESSER AUS METALL

Ürün Özellikleri		Product Properties		Produkt Eigenschaften	
Gövde	Alüminyum	Body	Aluminum	Körper	Aluminium
Mekanizma	Otomatik Kilit	Mechanism	Auto Lock	Mechanismus	Automatische Sperre
Renk Seçenekleri		Colour options		Farboptionen	
Uzunluk (mm)	165	Length (mm)	165	Länge (mm)	165
Bıçak Genişliği (mm)	18	Blade Width (mm)	18	Klingenbreite (mm)	18
Ağırlık (Gram)	110	Weight (Grams)	110	Gewicht (Gramm)	110



PROFESYONEL MAKET BIÇAĞI METAL GÖVDE

PROFESSIONAL UTILITY KNIFE METAL BODY

PROFESSIONELLES GEBRAUCHSMESSER AUS METALL

Ürün Özellikleri		Product Properties		Produkt Eigenschaften	
Gövde	Alüminyum	Body	Aluminum	Körper	Aluminium
Mekanizma	Otomatik Kilit	Mechanism	Auto Lock	Mechanismus	Automatische Sperre
Renk Seçenekleri		Colour options		Farboptionen	
Uzunluk (mm)	140	Length (mm)	165	Länge (mm)	165
Bıçak Genişliği (mm)	9	Blade Width (mm)	18	Klingenbreite (mm)	18
Ağırlık (Gram)	43	Weight (Grams)	110	Gewicht (Gramm)	110



PROFESYONEL MAKET BIÇAĞI PLASTİK GÖVDE

PROFESSIONAL UTILITY KNIFE PLASTIC BODY

PROFESSIONELLES GEBRAUCHSMESSER AUS KUNSTSTOFF

Ürün Özellikleri		Product Properties		Produkt Eigenschaften	
Gövde	Plastik	Body	Plastic	Körper	Kunststoff
Mekanizma	Otomatik Kilit	Mechanism	Auto Lock	Mechanismus	Automatische Sperre
Renk Seçenekleri	Sarı	Colour options	Yellow	Farboptionen	Gelb
Uzunluk (mm)	100	Length (mm)	100	Länge (mm)	100
Bıçak Genişliği (mm)	18	Blade Width (mm)	18	Klingenbreite (mm)	18
Ağırlık (Gram)	46	Weight (Grams)	46	Gewicht (Gramm)	46



HASSAS KESİM MAKET BIÇAĞI

PRECISION CUT UTILITY KNIFE

UNIVERSALMESSER MIT PRÄZISIONSSCHNITT

Ürün Özellikleri		Product Properties		Produkt Eigenschaften	
Gövde	Paslanmaz Çelik	Body	Stainless Steel	Körper	Rostfreier Stahl
Mekanizma	Otomatik Kilit	Mechanism	Auto Lock	Mechanismus	Automatische Sperre
Renk Seçenekleri		Colour options		Farboptionen	
Uzunluk (mm)	130	Length (mm)	130	Länge (mm)	130
Bıçak Genişliği (mm)	9	Blade Width (mm)	9	Klingenbreite (mm)	9
Ağırlık (Gram)	12	Weight (Grams)	12	Gewicht (Gramm)	12



KAZIMA BIÇAĞI

SCRAPING KNIFE

SCHABMESSER

Ürün Özellikleri		Product Properties		Produkt Eigenschaften	
Gövde	Plastik	Body	Plastic	Körper	Kunststoff
Renk Seçenekleri		Colour options		Farboptionen	
Uzunluk (mm)	180	Length (mm)	180	Länge (mm)	180
Bıçak Genişliği (mm)	60	Blade Width (mm)	60	Klingenbreite (mm)	60
Ağırlık (Gram)	29	Weight (Grams)	29	Gewicht (Gramm)	29



MAKET BIÇAK

UTILITY KNIFE

MODELL MESSER

ÜRÜN TANIMI PRODUCT DESCRIPTION PRODUKT BESCHREIBUNG	PLASTİK MAKET BIÇAĞI UTILITY KNIFE PLASTIC BODY GEBRAUCHSMESSER AUS KUNSTSTOFF	METAL MAKET BIÇAĞI UTILITY KNIFE METAL BODY GEBRAUCHSMESSER AUS METALL
MALZEME MATERIAL MATERIAL	PLASTİK PLASTIC KUNSTSTOFF	ALÜMİNYUM ALUMINUM ALUMINIUM
RENK COLOUR FARBE	MAVİ BLUE BLAU	GÜMÜŞ GRİ SILVER GREY SILBER-GRAU
BIÇAK BİLGİLERİ KNIFE INFORMATION MESSER INFORMATIONEN	ÜRÜN GÖRSELİ PRODUCT IMAGE PRODUKT BILD	
MALZEME MATERIAL MATERIAL	KARBON ÇELİĞİ CARBON STEEL KOHLENSTOFFSTAHL	
GENİŞLİK WIDTH BREITE	18mm	
KALINLIK THICKNESS DICKE	0,5mm	
UZUNLUK LENGTH LÄNGE	100 mm (0,5x18x100mm)	

MAKET BIÇAK YEDEĞİ

CUTTER BLADE

SCHNEIDMESSER

MALZEME MATERIAL MATERIAL	KROM KAPLAMA ÇELİK	
GENİŞLİK WIDTH BREITE	18mm	
KALINLIK THICKNESS DICKE	0,5mm	
UZUNLUK LENGTH LÄNGE	100 mm (0,5x18x100mm)	

TORNAVIDALAR

SCREWDRIVERS

SCHRAUBENDREHER

ÖLÇÜLERİ DIMENSIONS MASSE	ÇEŞİTLERİ TYPES TYPEN	AĞIRLIK (gram) WEIGHT (grams) GEWICHT (gramm)	MALZEME MATERIAL MATERIAL
3*40	DÜZ - YILDIZ FLAT - STAR FLACH - STERN	20	ÇELİK UÇ PLASTİK SAP STEEL TIP PLASTIC HANDLE STAHLSPITZE KUNSTSTOFFGRIFF
3*80		35	
4*80		50	
4*100		37	
4*125		45	
5*80		50	
5*100		55	
5*125		60	
5*150		65	
6*100		65	
6*125		70	
6*150		75	
6*175		80	
7*125		120	
7*150		130	
7*175		135	
8*150		145	
8*175		150	
8*200		160	
9*200		190	
11*250	305		

TEKNİK ÇİZİM

TECHNICAL DRAWING

TECHNISCHE ZEICHNUNG

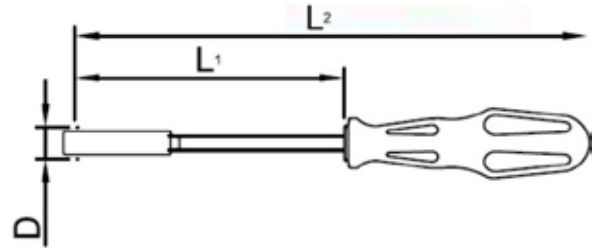

KESER

ADZE

DECHSEL

AĞIRLIK (gram) WEIGHT (grams) GEWICHT (gramm)	636	
AĞAÇ SAP HARDWOOD HANDLE DECHSEL	400mm	
MALZEME MATERIAL	DÖKME DEMİR PIG IRON ROHEISEN	

PÜR MÜZ

BLOWER

GEBLASE



Ürün Özellikleri

Ürün alüminyum kasadan oluşmaktadır.

Ürün içerisinde gaz yoktur kullanıcıların dolumu kendisi yapması gerekmektedir.

Ateş sabitlemesi ile tetikten elinizi çekseniz bile ateşlemeye devam etmektedir.

Gaz ayarı ile istediğiniz seviyede gaz basıncını ayarlayabilirsiniz.

1300 derece sıcaklığa dayanıklıdır.

BOY	ATEŞLEME BORUSU	GAZ DEPO ÇAP	GAZ DEPO UZUNLUK
17 CM	7 CM	5 CM	11 CM

Product Properties

The product consists of an aluminum case.

There is no gas in the product, users have to fill it themselves.

It continues to fire even if you take your hand off the trigger with the fire fixation.

With the gas adjustment, you can adjust the gas pressure at the desired level.

It is resistant to 1300 degrees temperature.

SIZE	IGNITION PIPE	GAS TANK DIAMETER	GAS TANK LENGTH
17 CM	7 CM	5 CM	11 CM

Produkt Eigenschaften

Das Produkt besteht aus einem Aluminiumgehäuse.

Das Produkt enthält kein Gas, Benutzer müssen es selbst einfüllen.

Es feuert weiter, auch wenn man mit der Feuerfixierung die Hand vom Abzug nimmt.

Mit der Gaseinstellung können Sie den Gasdruck auf das gewünschte Niveau einstellen.

Es ist beständig gegen 1300 Grad Temperatur.

GRÖSSE	ZÜNDROHR	DURCHMESSER DES BENZINTANKS	LÄNGE DES BENZINTANKS
17 CM	7 CM	5 CM	11 CM

ZAMAK DÜBEL

ZAMAK DOWEL

ZAMAK-DÜBEL

SIZE	M6	M6	M8	M8	M10
MALZEME MATERIAL MATERIAL	ZAMAK	ZAMAK	ZAMAK	ZAMAK	ZAMAK
ÖLÇÜLERİ DIMENSIONS MASSE	8X13	8X11	10X20	10X15	13X17
FORM FORM GESTALT	ALTI KÖŞEBAŞ COUNTERSUNK HEAD SENKKOPF	ALTI KÖŞEBAŞ COUNTERSUNK HEAD SENKKOPF	ALTI KÖŞEBAŞ COUNTERSUNK HEAD SENKKOPF	ALTI KÖŞEBAŞ COUNTERSUNK HEAD SENKKOPF	ALTI KÖŞEBAŞ COUNTERSUNK HEAD SENKKOPF



KELEPÇELER

CLAMPS

KLEMMEN

ÖLÇÜLERİ DIMENSIONS MASSE	BANT GENİŞLİĞİ BAND WIDTH BANDBREITE	ÜRÜN TİPİ PRODUCT TYPE PRODUKTART	HAMMADDE RAW MATERIALS ROHES MATERIAL	ÜRÜN GÖRSELİ PRODUCT IMAGE PRODUKTBILD
8*13	8mm	A	DKP	
10*16	8mm	A	DKP	
13*19	8mm	A	DKP	
16*23	8mm	A	DKP	
18*25	8mm	A	DKP	
19*26	13mm	B	DKP	
20*30	13mm	B	DKP	
22*36	13mm	B	DKP	
25*42	13mm	B	DKP	
28*48	13mm	B	DKP	
32*51	13mm	B	DKP	
38*58	13mm	B	DKP	
44*64	13mm	B	DKP	
51*72	13mm	B	DKP	
57*76	13mm	B	DKP	
65*82	13mm	B	DKP	
76*92	13mm	B	DKP	
85*103	13mm	B	DKP	
92*110	13mm	B	DKP	
105*121	13mm	B	DKP	
115*135	13mm	B	DKP	
130*146	13mm	B	DKP	
146*164	13mm	B	DKP	

STD ŞİŞME TEKER

INFLATABLE WHEEL

AUFBLASBARES RAD

ÇEŞİTLERİ TYPES TYPEN	METAL JANT ŞİŞME TEKER METAL RIM PNEUMATIC WHEEL LUFTRAD MIT METALLFELGE	PLASTİK JANT ŞİŞME TEKER PLASTIC RIM PNEUMATIC WHEEL KUNSTSTOFFFELGE LUFTRAD	PU TEKER PU WHEEL PU-RAD	İÇ TEKER INNER WHEEL INNERES RAD
MALZEME MATERIAL	KAUÇUK RUBBER GUMMI	KAUÇUK RUBBER GUMMI	KAUÇUK RUBBER GUMMI	KAUÇUK RUBBER GUMMI
JANT RIM FEDGE	GALVANIZED SHEET	PLASTIC	GALVANIZED SHEET	-
AĞIRLIK (gram) WEIGHT (grams) GEWICHT (gramm)	2,15 kg	2 kg	2,15 kg	0,3 kg
TAŞIMA KAPASİTESİ CARRYING CAPACITIES TRAGKAPAZITÄTEN	110 kg	110 kg	110 kg	-
BASINÇ (BAR) PRESSURE (BAR) DRUCK (BAR)	1,38	1,38	1,38	-
SAC KALINLIĞI THICKNESS DICKE	1 mm	-	1 mm	-
TEKERLEK ÇAPI WHEEL DIAMETER RADDURCHMESSER	345 mm	345 mm	345 mm	-
TEKERLEK GENİŞLİĞİ WHEEL WIDTH RADBREITE	77 mm	77 mm	77 mm	-
JANT ÇAPI WHEEL DIAMETER RADDURCHMESSER	205 mm	205 mm	205 mm	-
RULMAN İÇ ÇAP BEARING INSIDE DIAMETER LAGERINNENDURCHMESSER	20 mm	20 mm	20 mm	-
ÜRÜN GÖRSELİ PRODUCT IMAGE PRODUKTBIID				

KIL FİTİL

WHEATHER STRIP

WETTERSTREIFEN

ÇEŞİTLERİ TYPES TYPEN	STANDART SERİ STANDARD SERIES STANDARDSERIE	FİNLİ SERİ FIN SERIES
ÖLÇÜLERİ DIMENSIONS MASSE	KULLANIM ALANLARINA GÖRE FARKLI ÖLÇÜ VE YOĞUNLUKTA ÜRÜN MEVCUTTUR. PRODUCTS ARE AVAILABLE IN DIFFERENT SIZES AND DENSITY ACCORDING TO THE AREAS OF USAGE. PRODUKTE SIND IN UNTERSCHIEDLICHEN GRÖSSEN UND DICHTEN ENTSPRECHEND DEN ANWENDUNGSBEREICHEN ERHÄLTlich.	
HAMMADDE RAW MATERIALS ROHES MATERIAL	POLİPROPİLEN	POLİPROPİLEN
DETAY DETAIL DETAIL	SİLİKONLU SILICONE SİLİKON	SİLİKONLUDUR. ORTASINDAKİ FİNLİ ŞERİT SAYESİNDE SIZDIRMAZIK ÖZELLİĞİNİ ARTIRIR. IT IS SILICONE. INCREASES ITS LEAKING PROPERTIES THANKS TO THE FINISHED STRIP IN THE MIDDLE. ES İST SİLİKON. ERHÖHT SEINE AUSLAUFEIGENSCHAFTEN DURCH DEN FERTIGEN STREIFEN IN DER MITTE.
	KIL FİTİL PVC, ALÜMİNYUM VEYA AHŞAPTAN YAPILAN KAPI VE PENCERELERDE SU, TOZ VE SES GİBİ İSTENMEYEN FAKTÖRLERİ DIŞARIDA TUTAN BİR MALZEMEDİR. THE MATERIAL THAT KEEPS UNDESİRED FACTORS SUCH AS WATER, DUST AND SOUND ON DOORS AND WINDOWS MADE OF PVC, ALUMINUM OR WOOD. DİESER MATERIAL İST EIN MATERIAL, DAS UNERWÜNSCHTE FAKTOREN WIE WASSER, STAUB UND SCHALL AUF TÜREN UND FENSTER AUS PVC, ALUMINIUM ODER HOLZ HÄLT.	



DÜZ SİNEK TELİ

FIBERGLASS INSET SCREEN

FIBERGLAS INSET SCREEN

ÖLÇÜLERİ DIMENSIONS MASSE	60 cm	80 cm	100 cm	120 cm	140 cm	160 cm	180 cm
AĞIRLIK (gram/m ²) WEIGHT (grams/m ²) GEWICHT (gramm/m ²)	105	105	105	105	105	105	105
UZUNLUK (m/top) LENGTH (m/roll) LÄNGE (m/rollen)	30	30	30	30	30	30	30
MALZEME MATERIAL	%35 YÜKSEK KALİTELİ FİBERGLAS İPLİĞİ + %65 PLASTİKTİR. 35% HIGH QUALITY FIBERGLASS YARN + 65% PLASTIC. 35 % HOCHWERTIGES GLASFASERGARN + 65 % KUNSTSTOFF.						
KARE SAYISI NUMBER OF SQUARE ANZAHL DES QUADRATS	1x1 ÖLÇÜSÜNDE 16*18 KARE BULUNUR. (1 inch 25,4 mm) THERE IS 16*18 SQUARE IN 1x1 MEASUREMENT. (1 inch 25.4 mm) ES GIBT 16 * 18 QUADRATISCHE IN 1 x 1 MESSUNG. (1 Zoll 25,4 mm)						

PİLELİ SİNEK TELİ

PLEATED WIREMESH

PLISSIERTES DRAHTGEWEBE

ÖLÇÜLERİ DIMENSIONS MASSE	2,00 M	2,20 M	2,40 M	2,60 M	2,80 M
AĞIRLIK (gram/m ²) WEIGHT (grams/m ²) GEWICHT (gramm/m ²)	110	110	110	110	110
UZUNLUK (m/top) LENGTH (m/roll) LÄNGE (m/rollen)	30	30	30	30	30
PİLE YÜKSEKLİĞİ PLEAT HEIGHT FALTENHÖHE	15 mm	15 mm	15 mm	15 mm	15 mm
MALZEME MATERIAL	YÜKSEK KALİTELİ %40 FİBERGLAS İPLİĞİ + %65 POLYESTER İPLİĞİ. HIGH QUALITY %40 FIBERGLASS YARN + 60% POLYESTER YARN. HOCHWERTIGES %40 GLASFASERGARN + 60% POLYESTER HERGESTELLT.				
KARE SAYISI NUMBER OF SQUARE ANZAHL DES QUADRATS	1x1 ÖLÇÜSÜNDE 16*18 KARE BULUNUR. (1 inch 25,4 mm) THERE IS 16*18 SQUARE IN 1x1 MEASUREMENT. (1 inch 25.4 mm) ES GIBT 16 * 18 QUADRATISCHE IN 1 x 1 MESSUNG. (1 Zoll 25,4 mm)				

STD BANTLAR

KOLİ BANTLARI

DUCT TAPE

KLEBEBAND

ÇEŞİTLERİ TYPES TYPEN	AKRİLİK KOLİ BANDI ACRYLIC BOX TAPE KASTENBAND AUS ACRYL	HOTMELT KOLİ BANDI HOTMELT BOX TAPE KASTENKLEBEBAND HOTMELT
MALZEME MATERIAL MATERIAL	TUTKALLANMIŞ ÇİFT YÖNLÜ POLİPROPİLEN FİLM GLUEED DUPLEX POLYPROPYLENE FILM GELEBTE BIDIREKTIONALE POLYPROPYLENFOLIE	
KULLANIM AMACI PURPOSE OF USAGE NUTZUNGSZWECK	PLASTİK VE NAYLON YÜZEYLERDE KULLANILIR. USED ON PLASTIC AND NYLON SURFACES AUF KUNSTSTOFF- UND NYLON OBERFLÄCHEN VERWENDET.	KARTON KAPATMADA KULLANILIR. IT IS USED FOR COVERING CARTON. ES WIRD ZUM ABDECKEN VON KARTON VERWENDET.

TEKNİK ÖZELLİKLER	TECHNICAL SPECIFICATIONS	TECHNISCHE DATEN
	EN, WIDTH, BREITE	45 mm
	BOY, SIZE, GRÖSSE	100 m

KOLİ BANDI KESME MAKİNESİ

DUCT TAPE CUTTING MACHINE

KASTENBANDSCHNEIDEMASCHINE

AĞIRLIK (gram) WEIGHT (grams) GEWICHT (gramm)	313	
MALZEME MATERIAL	METAL	
RENK COLOUR FARBE	MAVİ BLUE BLAU	

MASKELEME BANTLARI

MASKING TAPE

ABDECKBAND

ÇEŞİTLERİ TYPES TYPEN	HOTMELT MASKELEME	DOĞAL KAUÇUK MASKELEME
MALZEME MATERIAL MATERIAL	KAUÇUK EMDİRİLMİŞ KAĞIT BANT RUBBER IMPRESSED PAPER TAPE GUMMIGEDRUCKTES PAPIERBAND	
KULLANIM AMACI PURPOSE OF USAGE NUTZUNGSZWECK	Boya, Otomotiv ve Mobilya/İnşaat sektörlerinde kullanılır. It is used in Paint, Automotive and Furniture/Construction sectors. Es wird in den Bereichen Farben, Automobil und Möbel/Bau eingesetzt.	

HOTMELT MASKELEME ÖLÇÜ TABLOSU / HOTMELT MASKING MEASUREMENT TABLE / MESSTABELLE FÜR HOTMELT-MASKING

EN, WIDTH, BREITE	18mm	24mm	36mm	48mm
BOY, SIZE, GRÖSSE	25 m	25 m	25 m	25 m

DOĞAL KAUÇUK MASKELEME ÖLÇÜ TABLOSU / NATURAL RUBBER MASKING MEASUREMENT TABLE / NATURKAUTSCHUK-MASKING-MESSTABELLE

EN, WIDTH, BREITE	18mm	24mm	36mm	48mm
BOY, SIZE, GRÖSSE	25 m	25 m	25 m	25 m

DERZ BANTLAR

JOINT TAPE

FUGENBAND

ÖLÇÜ DIMENSIONS MASSE	50MM*45M	50MM*90M	100MM*90M
AĞIRLIK WEIGHT GEWICHT	123	247	450
KULLANIM AMACI PURPOSE OF USAGE NUTZUNGSZWECK	<p>Alçı levha, duvar ve asma tavan sistemlerinin yapımında, ek yerlerinde çatlakları önlemek amacı ile kullanılan kendinden yapışkanlı cam elyaf banttir.</p> <p>It is a self-adhesive glass fiber tape used in the construction of plasterboard, wall and suspended ceiling systems, to prevent cracks in the joints.</p> <p>Es ist ein selbstklebendes Glasfaserband, das beim Bau von Gipskarton-, Wand- und abgehängten Deckensystemen verwendet wird, um Risse in den Fugen zu vermeiden.</p>		
TEKNİK ÖZELLİKLER TECHNICAL SPECIFICATIONS TECHNISCHE DATEN	<p>1x1 ÖLÇÜSÜNDE 8*8 KARE BULUNUR. (1 inch 25,4 mm) IT HAS 8*8 SQUARE IN 1x1 SIZE. (1 inch 25.4 mm) ES HAT 8 * 8 QUADRAT IN 1 x 1 GRÖSSE. (1 Zoll 25,4 mm)</p> <p>METREKARE AĞIRLIĞI 50 GRAMDİR. WEIGHT OF SQUARE METER IS 50 GRAMS. GEWICHT DES QUADRATMETERS IST 50 GRAMM.</p>		

ELEKTRİKÇİ BANDI

ELECTRICIAN BAND

ELEKTRIKER-BAND

RENK COLOUR FARBE	SİYAH BLACK SCHWARZ	KIRMIZI RED ROT	BEYAZ WHITE WEISS	MAVİ BLUE BLAU	SARI YELLOW GELB	GRİ GREY GRAU
MALZEME MATERIAL MATERIAL	<p>Kauçuk yapıştırıcı ile kaplanmış PVC film. PVC film coated with rubber adhesive. PVC-Folie mit Kautschukkleber beschichtet.</p>					
KULLANIM AMACI PURPOSE OF USAGE NUTZUNGSZWECK	<p>Elektrik, ısı, ses yalıtımı ve Split Klimaların boru yalıtımlarında kullanılır. Çeliğe yapışma mukavemeti 2,0 N/m.</p> <p>It is used in electricity, heat, sound insulation and pipe insulation of Split Air Conditioners. Adhesion strength to steel 2.0 N/m.</p> <p>Es wird in der Strom-, Wärme-, Schalldämmung und Rohrisolierung von Split-Klimaanlagen verwendet. Haftfestigkeit auf Stahl 2,0 N/m.</p>					

TEKNİK ÖLÇÜLERİ	TECHNICAL DIMENSIONS	TECHNISCHE ABMESSUNGEN
EN, WIDTH, BREITE	19 mm	
BOY, SIZE, GRÖSSE	10 YARDA = 9,14M	10 YARDS = 9,14M

KANAL BANDI

CHANNEL BAND

KANALBAND

KALINLIK (MİKRON) THICKNESS (MICRON) DICKE (MIKRON)	130 MİKRON 130 MICRON	
MALZEME MATERIAL MATERIAL	PVC	
KULLANIM AMACI PURPOSE OF USAGE NUTZUNGSZWECK	Neme, paslanmaya, aşınmaya, çürümeye, asit ve alkaliere karşı dayanıklıdır. It is resistant to moisture, rust, abrasion, rot, acid and alkali. Es ist beständig gegen Feuchtigkeit, Rost, Abrieb, Fäulnis, Säure und Lauge. Tüm hava şartlarına karşı koruma etkisi mevcuttur. Es hat eine Schutzwirkung gegen alle Wetterbedingungen. Poliüretan kauçuk boru ve levhaların montajında ısı ve ses yalıtımı için kullanılır. Es wird zur Wärme- und Schalldämmung bei der Montage von Rohren und Platten aus Polyurethankautschuk verwendet. It is used for heat and sound insulation in the assembly of polyurethane rubber pipes and sheets.	
TEKNİK ÖLÇÜLERİ	TECHNICAL DIMENSIONS	TECHNISCHE ABMESSUNGEN
KALINLIK, THICKNES, DICKE	1,30 mm	
EN, WIDTH, BREITE	48mm	
BOY, SIZE, GRÖSSE	25 YARDA = 22 M 25 YARDS = 22 M	
Çeliğe Yapışma Mukavemeti Adhesion Strength to Steel Haftfestigkeit auf Stahl	1.5 N/cm	
Çekme Dayanımı Tensile Strength Zugfestigkeit	23.6 N/cm	
Kopma Esnemesi Breaking Stretch Dehnung Brechen	2,4	

TEFLON BANT

TEFLON TAPE

TEFLONBAND

ÖLÇÜ DIMENSIONS MASSE	12mm* 0,075mm* 10m	12mm* 0,075mm* 10m	
RENK COLOUR FARBE	BEYAZ WHITE WEISS	BEYAZ WHITE WEISS	
YOĞUNLUK INTENSITY INTENSITÄT	0,3 g/ cm³	0,25 g/ cm³	
NET AĞIRLIK NET WEIGHT REINGEWICHT	2,7 g	2,7 g	
DETAY DETAIL DETAIL	YAPIŞKAN ÖZELLİĞİ YOKTUR. NOT ADHESIVE NICHT KLEBEND		

YAPIŞKANLI TEFLON BANT

ADHESIVE TEFLON TAPE

KLEBENDES TEFLONBAND

GENİŞLİK WIDTH BREITE	1 METRE	
UZUNLUK LENGTH LÄNGE	50 METRE	
PTFE KUMAŞ KALINLIĞI PTFE-GEWEBE DICKE PTFE FABRIC THICKNESS	0,11 mm	
YAPIŞKANLIK KALINLIĞI ADHESIVE THICKNESS KLEBSTOFFDICKE	0,05 mm	
TOPLAM MİKRON KALINLIĞI GESAMTMİKRONDICKE TOTAL MICRON THICKNESS	0,16 mm	
SICAKLIK DAYANIMI TEMPERATURE RESISTANCE TEMPERATURBESTÄNDIGKEIT	-70° ~ 260°	
DETAY DETAIL DETAIL	‘İSİYA DAYANIKLI YAPIŞKAN ÖZELLİĞİ VARDIR. IT HAS HEAT RESISTANT ADHESIVE FEATURE. ES HAT WÄRMEBESTÄNDIGE KLEBEFUNKTION.	
	‘TÜM KİMYASAL MADDELERE KARŞI DAYANIMI VARDIR. IT IS RESISTANT AGAINST ALL CHEMICALS ES IST BESTÄNDIG GEGEN ALLE CHEMIKALIEN	
	PLASTİK KESME VE PAKETLEME MAKİNALARINDA, PRES MAKİNALARININ SİLİNDİR YÜZEYİNE KAPLAMA BANDI OLARAK KULLANILIR. KİRLENMEYİ VE KOROZYONU ENGELLER. IT IS USED IN PLASTIC CUTTING AND PACKAGING MACHINES AS COATING TAPE ON THE CYLINDER SURFACE OF PRESSING MACHINES. PREVENT CONTAMINATION AND CORROSION. ES WIRD IN KUNSTSTOFFSCHNEIDE- UND VERPACKUNGSMASCHINEN ALS BESCHICHTUNGSBAND AUF DER ZYLINDEROBERFLÄCHE VON PRESSMASCHINEN VERWENDET. VERMEIDEN SIE KONTAMINATION UND KORROSION.	

İKAZ BANDI

WARNING TAPE

WARNBAND



Ürün Özellikleri

ÖLÇÜ	60 mm*180 m & 60 mm*360 m
KALINLIK	30 MİKRON
HAMMADDE	PVC
EN	60 mm
BOY	180 m & 360 m

Product Properties

MEASUREMENT	60 mm*180 m & 60 mm*360 m
THICKNESS	30 MICRON
RAW MATERIALS	PVC
MOST	60 mm
SIZE	180 m & 360 m

Produkt Eigenschaften

MESSUNG	60 mm*180 m & 60 mm*360 m
DICKE	30 MİKRON
ROHES MATERIAL	PVC
DIE MEISTEN	60 mm
GRÖSSE	180 m & 360 m

SIZDIRMAZ BANT

SEALING TAPE

ABDICHTUNGSBAND

EN, WIDTH, BREITE	38 mm	
BOY, SIZE, GRÖSSE	3 m	
RENK COLOUR FARBE	Beyaz White Weiß	
KULLANIM AMACI PURPOSE OF USAGE NUTZUNGSZWECK	<p>Kolay uygulanabilir olması, esnek yapısı, küf ve mantar oluşturmayan PVC kaplaması sayesinde temiz bir görünüm sağlar. Genel olarak ıslak zeminlerde tercih edilen sızdırmazlık bandı banyo, mutfak, evye, duşakabin, küvet gibi suyun sızabileceği yerlerde silikon yerine kullanılabilir.</p> <p>It provides a clean appearance thanks to its easy application, flexible structure and PVC coating that does not form mold and fungus. The sealing tape, which is generally preferred on wet floors, can be used instead of silicone in places where water may leak, such as bathrooms, kitchens, sinks, shower cabins, bathtubs.</p> <p>Dank seiner einfachen Anwendung, flexiblen Struktur und PVC-Beschichtung, die keinen Schimmel und Pilz bildet, sorgt es für ein sauberes Erscheinungsbild. An Stellen, an denen Wasser austreten kann, wie z. B. Badezimmer, Küchen, Waschbecken, Duschkabinen, Badewannen, kann anstelle von Silikon das Dichtband verwendet werden, das generell auf nassen Böden bevorzugt wird.</p>	

ZEMİN KAYDIRMAZ BANT

FLOOR ANTI-SLIP TAPE

BODEN-ANTIRUTSCH-BAND

EN, WIDTH, BREITE	25 mm	50 mm	
BOY, SIZE, GRÖSSE	5 m- 15 m- 25 m	5 m- 15 m- 25 m	
RENK COLOUR FARBE	Siyah Black Schwarz		
KULLANIM AMACI PURPOSE OF USAGE NUTZUNGSZWECK	<p>Zemin Kaydırmazlık Bandı, mineral yapısı sayesinde kaymayı önler. Kendinden yapışkanlıdır. Uygulaması kolaydır.</p> <p>Floor Anti-Slip Tape prevents slipping thanks to its mineral structure. It is self adhesive. It is easy to apply.</p> <p>Floor Anti-Rutsch Tape verhindert durch seine mineralische Struktur ein Verrutschen. Es ist selbstklebend. Es ist einfach anzuwenden.</p>		

BANYO KAYDIRMAZ BANT

BATH NON-SLIP TAPE

BAD RUTSCHFESTES BAND

EN, WIDTH, BREITE	36 mm	
BOY, SIZE, GRÖSSE	2,5 m	
RENK COLOUR FARBE	Şeffaf Transparent	
KULLANIM AMACI PURPOSE OF USAGE NUTZUNGSZWECK	<p>Spor salonları, havuz kenarları, duş, küvet gibi kayma tehlikesi olan zeminlerde kullanıma uygundur. Deterjan ve türevlerinden etkilenmez. Uzun ömürlüdür.</p> <p>It is suitable for use on surfaces where there is a risk of slipping, such as gyms, pool sides, showers and bathtubs. It is not affected by detergents and derivatives. It is long lasting.</p> <p>Es eignet sich für den Einsatz auf rutschgefährdeten Flächen wie Turnhallen, Beckenumrandungen, Duschen und Badewannen. Es wird nicht durch Detergenzien und Derivate angegriffen. Es ist langlebig.</p>	

ÇİFT TARAFLI AKRİLİK KÖPÜK BANTLAR

ACRYLIC DOUBLE-SIDED TAPES

DOPPELSEITIGE ACRYL-BÄNDER

MALZEME MATERIAL	Akrilik Acrylic Acryl	
TAŞIYICI CARRIER TRÄGER	Akrilik köpük Acrylic foam Acrylschaum	
KALINLIK, THICKNES, DICKE	1 mm , 0,5mm , 0,8 mm , 2mm, 3mm	
KULLANIM AMACI PURPOSE OF USAGE NUTZUNGSZWECK	<p>Akrilik çift taraflı bantlar, dayanıklılıkları ve güçlü yapışkan özellikleri sayesinde çeşitli sektörlerde kullanılmaktadır. Bu bantlar, farklı yüzeyler arasında sıkıca yapışır ve ürünlerin güvenli şekilde taşınmasına ve monte edilmesine yardımcı olur.</p> <p>Acrylic double-sided tapes are used in various sectors thanks to its durability and strong adhesive properties. These tapes adhesive tightly between different surfaces and assists the safe handling and assembly of products.</p> <p>Aacryl-doppelseitige klebebänder werden in verschiedenen sektoren dank ihrer langlebigkeit und starken klebeeigenschaften verwendet. Diese klebebänder kleben fest zwischen verschiedenen oberflächen und unterstützen die sichere handhabung und montage von produkten.</p>	

ÇİFT TARAFLI AKRİLİK OPP BANTLAR

OPP DOUBLE-SIDED TAPES

DOPPELSEITIGE OPP-BÄNDER

MALZEME MATERIAL	Hotmelt Hotmelt Hotmelt	
TAŞIYICI CARRIER TRÄGER	Bopp Bopp Bopp	
KALINLIK, THICKNES, DICKE	28 µm	
KULLANIM AMACI PURPOSE OF USAGE NUTZUNGSZWECK	<p>Genel amaçlı çift taraflı bant. Kağıt, karton, poster yapıştırıcılarında önerilir.</p> <p>General purpose double sided tape. Recommended for paper, carton, poster adhesives.</p> <p>Allgemeines doppelseitiges klebeband. Empfohlen für papier, karton, plakatklebstoffe.</p>	

TAMİR BANDI

REPAIR TAPE

REPARATURBAND

MALZEME MATERIAL	Sentetik kauçuk Synthetic rubber Synthesekautschuk	
TAŞIYICI CARRIER TRÄGER	Pe kaplı bez Pe coated cloth Pe-beschichtetes tuch	
KALINLIK, THICKNES, DICKE	0,147 mm	
KULLANIM AMACI PURPOSE OF USAGE NUTZUNGSZWECK	<p>Tamir bandı, araçların, ev ve eşyaların veya herhangi bir malzemenin hasar görmesini önlemek veya tamir etmek için kullanılabilir.</p> <p>Repair tape can be used to prevent or repair damage to vehicles, home or any materials.</p> <p>Reparaturklebeband kann verwendet werden, um schäden an fahrzeugen, haus oder allen materialien zu verhindern oder zu reparieren.</p>	

ALÜMİNYUM FOLYO BANT

ALUMINUM FOIL TAPE

ALUMINIUMFOLIENBAND

MALZEME MATERIAL	Akrilik Acrylic Acryl	
TAŞIYICI CARRIER TRÄGER	Alüminyum folyo Aluminum foil Aluminiumfolien	
KALINLIK, THICKNES, DICKE	0,18 mm	
KULLANIM AMACI PURPOSE OF USAGE NUTZUNGSZWECK	<p>Yalıtım ve kaplama işlemleri dışında, alüminyum folyo tamir bantları, soğutma sistemleri, havalandırma sistemleri ve daha pek çok alanda kullanılmaktadır.</p> <p>Aside from insulation and coating, aluminum foil repair tapes are used in cooling systems, ventilation systems and more.</p> <p>Neben der isolierung und beschichtung werden reparaturbänder aus aluminiumfolie in kühlssystemen, lüftungssystemen und mehr verwendet.</p>	

YAPIŞKANLI KAPI PENCERE BANDI

ADHESIVE RUBBER WEATHERSTRIP

KLEBENDE GUMMI-DICHTSTREIFEN

ÇEŞİTLERİ TYPES TYPEN	İNCE THIN DÜNN		KALIN THICK	
ÖLÇÜLERİ DIMENSIONS MASSE	8x5 mm		9x6 mm	
TİP TYPE TYP	D TIP D TYPE D TYP		D TIP D TYPE D TYP	
UZUNLUK LENGTH LÄNGE	100 M (50x2) = 1 RULO 100 M (50x2) = 1 ROLL 100 M (50x2) = 1 ROLLEN		100 M (50x2) = 1 RULO 100 M (50x2) = 1 ROLL 100 M (50x2) = 1 ROLLEN	
AĞIRLIK (gram) WEIGHT (grams) GEWICHT (gramm)	1 KG/ RULO 1 KG/ ROLL 1 KG/ ROLLEN	1 KG/ RULO 1 KG/ ROLL 1 KG/ ROLLEN	1,3 KG/ RULO 1,3 KG/ ROLL 1,3 KG/ ROLLEN	1,3 KG/ RULO 1,3 KG/ ROLL 1,3 KG/ ROLLEN
RENK COLOUR FARBE	BEYAZ WHITE WEISS	KAHVERENGİ BROWN BRAUN	BEYAZ WHITE WEISS	KAHVERENGİ BROWN BRAUN
MALZEME MATERIAL MATERIAL	KENDİNDEN YAPIŞKANLI EPDM KÖPÜK KAUÇUK SELF-ADHESIVE EPDM FOAM RUBBER SELBSTKLEBENDES EPDM-SCHAUMGUMMI			





STD İNŞAAT

STD ŞERİT METRELER

MEASURING TAPE

MASSBAND

ÖLÇÜLERİ DIMENSIONS MASSE	3m*16mm	5m*19mm	5m*25mm
AĞIRLIK (gram) WEIGHT (grams) GEWICHT (gramm)	192	208	283
KASA RENGİ CASE COLOR GEHÄUSEFARBE	MAVİ BLUE BLAU		
KASA KORUMASI CASE PROTECTION KOFFERSCHUTZ	VAR YES JA		
OTOMATİK STOP ÖZELLİĞİ AUTO STOP FEATURE AUTO-STOP-FUNKTION	VAR YES JA		
KİLİT ÖZELLİĞİ LOCK FEATURE SPERRFUNKTION	VAR YES JA		
KEMER TOKASI BELT BUCKLE GÜRTELSCHNALLE	VAR YES JA		
TAŞIMA İPİ CARRY LINE ÜBERTRAGUNGSLINIE	VAR YES JA		

STDeKKo ŞERİT METRELER

MEASURING TAPE

MASSBAND

ÖLÇÜLERİ DIMENSIONS MASSE	3m*16mm	5m*19mm	5m*25mm
AĞIRLIK (gram) WEIGHT (grams) GEWICHT (gramm)	88	158	167
KASA RENGİ CASE COLOR GEHÄUSEFARBE	BEYAZ WHITE WEISS		
KASA KORUMASI CASE PROTECTION KOFFERSCHUTZ	YOK NO NEIN		
OTOMATİK STOP ÖZELLİĞİ AUTO STOP FEATURE AUTO-STOP-FUNKTION	YOK NO NEIN		
KİLİT ÖZELLİĞİ LOCK FEATURE SPERRFUNKTION	VAR YES JA		
KEMER TOKASI BELT BUCKLE GÜRTELSCHNALLE	VAR YES JA		
TAŞIMA İPİ CARRY LINE ÜBERTRAGUNGSLINIE	VAR YES JA		

SU TERAZİSİ

SPIRIT LEVEL

WASSERWAAGE

ÖLÇÜLERİ DIMENSIONS MASSE	40CM	50CM	60CM	80CM	100CM
MALZEME MATERIAL MATERIAL	ALUMİNYUM + MANYETİK ÖZELLİKLİ ALUMINUM + MAGNETIC ALUMINIUM + MAGNETISCH				
AĞIRLIK (gram) WEIGHT (grams) GEWICHT (gramm)	185	226	268	361	377

ÜRÜN GÖRSELİ

PRODUCT IMAGE

PRODUKT BILD



SIVA FILESİ

FIBERGLASS MESH

GLASFASERNETZ

ÖLÇÜLERİ DIMENSIONS MASSE	160 g	160 g	75 g
AĞIRLIK (gram/m ²) WEIGHT (grams/m ²) GEWICHT (gramm/m ²)	160	160	75
UZUNLUK (m/top) LENGTH (m/roll) LÄNGE (m/rollen)	50	50	50
RENK COLOUR FARBE	TURUNCU ORANGE	MAVİ BLUE BLAU	BEYAZ WHITE WEISS
MALZEME MATERIAL	HAMMADDESİ CAM ELYAFI OLUP, B+ KALİTEDİR. ITS RAW MATERIAL IS GLASS FIBER AND IS B+ QUALITY. SEIN ROHSTOFF IST GLASFASER UND IST B+ QUALITÄT.		
DETAY DETAIL	ÜRÜNLERİN ENİ 1 METRE BOYU 50 METREDİR. THE WIDTH OF THE PRODUCTS IS 1 METERS AND 50 METERS IN LENGTH. DIE BREITE DER PRODUKTE BETRÄGT 1 METER UND 50 METER IN DER LÄNGE.		
	1 TOP = 50 M ² . 1x1 ÖLÇÜSÜNDE 4*4 KARE BULUNUR. (1 inch 25,4 mm). 1 ROLL = 50 M ² . THERE ARE 4*4 SQUARE IN 1x1 SIZE. 1 ROLLEN = 50 M ² . ES GIBT 4 * 4 QUADRATISCHE IN 1 x 1 GRÖSSE.		
KULLANIM AMACI PURPOSE OF USAGE NUTZUNGSZWECK	BİNALARDA MANTOLAMADA VE SES YALITIMI İÇİN KULLANILIR. IT IS USED FOR HEATING AND SOUND INSULATION IN BUILDINGS. ES WIRD ZUR HEIZUNG UND SCHALLDÄMMUNG IN GEBÄUDEN VERWENDET.		

PVC KAPLI PUNTALI TEL

PVC COATED WELDED WIRE MESH

PVC-BESCHICHTETES GESCHWEISSTES DRAHTGEFLECHT

DELİK ÖLÇÜSÜ HOLE SIZE LOCHGRÖßE	12mm*12mm			25mm*25mm			50mm*50mm		
GENİŞLİK (m) WIDTH (m) BREITE (m)	1,00	1,20	1,50	1,00	1,20	1,50	1,00	1,20	1,50
TEL KALINLIĞI (mm) WIRE THICKNESS (mm) DRAHTSTÄRKE (mm)	0,90	0,90	0,90	1,60	1,60	1,60	2,00	2,00	2,00
UZUNLUK (m/top) LENGTH (m/roll) LÄNGE (m/rollen)	25	25	25	25	25	25	25	25	25
DETAY DETAIL DETAIL	<p>PVC kaplı kaynaklı teller koyu yeşil renktedir. Sertleştirilmiş tellerin kare şeklinde kaynaklanmasıyla üretilmiştir. Kaynaklanma işleminden sonra UV ışınlarına ve dona karşı dayanıklı kaliteli PVC ile kaplanmıştır. Kütles yapımında ve bahçe çevirme amacıyla kullanılır. En küçük kuşların dahi girmesini önler</p> <p>PVC coated welded wires are dark green in color. It is produced by welding hardened wires in a square shape. It is covered with high quality PVC resistant to UV rays and frost after welding. It is used in the construction of poultry houses and for the purpose of turning a garden. Prevents even the smallest birds from entering.</p> <p>PVC-beschichtete geschweißte Drähte haben eine dunkelgrüne Farbe. Es wird durch Schweißen von gehärteten Drähten in quadratischer Form hergestellt. Die erste ist mit hochwertigem PVC überzogen, das nach dem Schweißen UV-beständig und frostbeständig ist. Es wird beim Bau von Geflügelställen und zum Wenden eines Gartens verwendet. Verhindert das Eindringen selbst der kleinsten Vögel</p>								
MALZEME MATERIAL MATERIAL	PVC kaplı kaynakla birleştirilmiş tel PVC coated welded wire mesh PVC-beschichteter geschweißter Draht								

RABİS TELİ

METAL EXPANDED MESH

ERWEITERTES METALLGEWEBE

AĞIRLIK KG/RULO WEIGHT KG/ROLL GEWICHT KG/ROLL	9kg-25kg	
TEL KALINLIĞI WIRE THICKNESS	0,5mm	
DELİK ÖLÇÜSÜ HOLE SIZE LOCHGRÖßE	8x16-4x16	
RULO ÖLÇÜSÜ ROLL SIZE ROLLENGRÖßE	1x50m-1x20m	
MALZEME MATERIAL	GALVANİZLİ ÇELİK GALVANIZED STEEL VERZINKTER STAHL	

EMNİYET ALAN PERDESİ

SAFETY AREA CURTAIN

SICHERHEITSVORHANG



Ürün Özellikleri	
ÖLÇÜ	1M*50M
AĞIRLIK (gram)	3750 gr/adet & 75gr/m ²
DETAY	UV DAYANIMLI
MALZEME	Yüksek Yoğunluklu Polietilen

Product Properties	
MEASUREMENT	1M*50M
WEIGHT (grams)	3750 gr/pc & 75gr/m ²
DETAIL	UV RESISTANT
MATERIAL	High Density Polyethylene

Produkt Eigenschaften	
MESSUNG	1M*50M
GEWICHT (Gramm)	3750 g/Stück & 75 g/m ²
DETAIL	UV-BESTÄNDIG
MATERIAL	Polyethylen mit hoher Dichte

TRANSPALET

PALLET TRUCK

HUBWAGEN

ÇEŞİTLERİ TYPES TYPEN	CE BELGELİ CE CERTIFIED CE-ZERTIFIZIERT	CE BELGESİZ WITHOUT CE CERTIFICATE OHNE CE-ZERTIFIKAT
SAC KALINLIĞI THICKNESS DICKE	3 mm	3,75 mm
TEKERLEK WHEEL RAD	BEYAZ WHITE WEISS	KIRMIZI RED ROT
TEKERLEK MALZEME WHEEL MATERIAL RAD MATERIAL	POLYAMİD TEKER POLYAMIDE WHEEL POLYAMID-RAD	POLYAMİD ÜZERİ POLİÜRETAN KAPLI TEKER POLYURETHANE COATED WHEEL ON POLYAMIDE POLYURETHANBESCHICHTETE RÄDER AUF POLYAMID
RENK COLOUR FARBE	SARI YELLOW GELB	
TAŞIMA KAPASİTESİ CARRYING CAPACITIES TRAGKAPAZİTÄTEN	2500 kg	
TEK ÇATAL GENİŞLİĞİ SINGLE FORK WIDTH EINZELNE GABELBREITE	160 mm	
MİNİMUM ÇATAL YÜKSEKLİĞİ MINIMUM FORK HEIGHT MINDESTGABELHÖHE	85 mm	
MAKSİMUM ÇATAL YÜKSEKLİĞİ MAXIMUM FORK HEIGHT MAXIMALE GABELHÖHE	200 mm	



ÇATI SEMERİ

ROOF SADDLE

DACHSATTEL

ÖLÇÜLERİ DIMENSIONS MASSE	20x45mm	42x45mm
AĞIRLIK (gram) WEIGHT (grams) GEWICHT (gramm)	4,44	9,00
RENK COLOUR FARBE	RAL 9002, RAL 3004, RAL 3009, RAL 6020	
DETAY DETAIL DETAIL	<p>Çatı Semeri, montaj sırasında malzemenin zarar görmesini engeller. Vida deliğinden su sızdırma olasılığını ortadan kaldırır.</p> <p>The Roof Saddle prevents the material from being damaged during assembly. It eliminates the possibility of water leaking from the screw hole.</p> <p>Der Dachstuhl verhindert, dass das Material bei der Montage beschädigt wird. Es eliminiert die Möglichkeit, dass Wasser aus dem Schraubenloch austritt.</p>	
		

ÇİROZ

DISTANCE PIECE

DISTANZSTÜCK

AĞIRLIK (grams) WEIGHT (grams) GEWICHT(grams)	400	
TABLA KALINLIĞI TABLE THICKNESS TISCHDICKE	3mm-4mm	
U DEMİRİ KALINLIĞI U BAR THICKNESS U-STANGENDICKE	4mm-6mm	
MANDAL KALINLIĞI LATCH THICKNESS	1x50m-1x20m	
MANDAL MALZEMESİ LATCH MATERIAL VERRIEGELUNGSMATERIAL	SERTLEŞTİRİLMİŞ ÇELİK HARDENED STEEL GEHÄRTETER STAHL	
KAPLAMA COATING ÜBERZUG	ÇİNKO ZINC ZINK	

STD EL ALETLERİ

STANLEY KAYNAK MAKİNESİ

WELDING MACHINE

SCHWEISSGERÄT

MODEL NUMARASI MODEL NUMBER MODELLNUMMER	WD160IC	ELEKTROD ÇAPI ELECTRODE DIAMETER ELEKTRODEN-DURCHMESSER	1,6 -4,0mm
GİRİŞ VOLTAJİ INPUT VOLTAGE EINGANGSSPANNUNG	230V / 50-60Hz	KORUMA SINIFI PROTECTION CLASS SCHUTZKLASSE	IP21S
GÜÇ POWER ENERGIE	6,9 Kva / 5,2 KW	KORDON UZUNLUĞU CORD LENGTH SCHNURLÄNGE	1,5MT
BOŞTAKİ GERİLİM LOAD VOLTAGE LASTSPANNUNG	60V	KUTU ÖLÇÜLERİ(mm) BOX DIMENSIONS (mm) KASTENABMESSUNGEN (mm)	375X160X310
AKIM ARALIĞI CURRENT RANGE AKTUELLE BEREICH	10 - 60A	KUTU İÇİ AKSESUARLAR BOX ACCESSORIES KASTENZUBEHÖR	Kaynak maskesi, Kaynak fırçası, Elektrot pensi ve Topraklama pensi Welding mask, Welding brush, Electrode clamp and Grounding clamp Schweißmaske, Schweißbürste, Elektrodenklemme und Erdungsklemme
ÇALIŞMA VERİMLİLİĞİ OPERATIONAL EFFICIENCY ARBEITSEFFIZIENZ	20/160A 160A@60%		
DETAJ DETAIL DETAIL	<p>Motor bobin sargısı yoktur, elektronik kart sistemi ile çalışmaktadır. Makine içinde küçük bakır sargılı kondansatörler vardır. IGBT (İzole edilmiş kapılı, iki kutuplu transistör) has MMA invertör teknolojisine sahiptir. Turbo fanlı sağlam sac gövdeden oluşmaktadır. Hafif, kompakt, düşük tüketime sahip ve güvenilirdir.</p> <p>There is no motor coil winding, it works with the electronic card system. There are small copper-wound capacitors inside the machine. IGBT (Insulated gate, bipolar transistor) has MMA inverter technology. It consists of a solid sheet metal body with a turbo fan. It is light, compact, low consumption and reliable.</p> <p>Es gibt keine Motorspulenwicklung, es funktioniert mit dem elektronischen Kartensystem. In der Maschine befinden sich kleine kupfergewickelte Kondensatoren. IGBT (Insulated Gate, Bipolar Transistor) verfügt über MMA-Wechselrichtertechnologie. Er besteht aus einem massiven Blechkörper mit Turbogebälse. Es ist leicht, kompakt, verbrauchsarm und zuverlässig.</p>		



STANLEY KAYNAK MAKİNESİ

WELDING MACHINE

SCHWEISSGERÄT

MODEL NUMARASI MODEL NUMBER MODELLNUMMER	WD200IC	ELEKTROD ÇAPI ELECTRODE DIAMETER ELEKTRODEN-DURCHMESSER	1,6 -5,0mm
GİRİŞ VOLTAJİ INPUT VOLTAGE EINGANGSSPANNUNG	230V / 50-60Hz	KORUMA SINIFI PROTECTION CLASS SCHUTZKLASSE	IP21S
GÜÇ POWER ENERGIE	9 Kva / 7 KW	KORDON UZUNLUĞU CORD LENGTH SCHNURLÄNGE	1,5MT
BOŞTAKİ GERİLİM LOAD VOLTAGE LASTSPANNUNG	65V	KUTU ÖLÇÜLERİ(mm) BOX DIMENSIONS (mm) KASTENABMESSUNGEN (mm)	375X160X310
AKIM ARALIĞI CURRENT RANGE AKTUELLE BEREICH	15 - 200A	KUTU İÇİ AKSESUARLAR BOX ACCESSORIES KASTENZUBEHÖR	Kaynak maskesi, Kaynak fırçası, Elektrot pensi ve Topraklama pensi Welding mask, Welding brush, Electrode clamp and Grounding clamp Schweißmaske, Schweißbürste, Elektrodenklemme und Erdungsklemme
ÇALIŞMA VERİMLİLİĞİ OPERATIONAL EFFICIENCY ARBEITSEFFIZIENZ	20/200A 200A@60%		
DETAY DETAIL DETAIL	<p>Motor bobin sargısı yoktur, elektronik kart sistemi ile çalışmaktadır. Makine içinde küçük bakır sargılı kondansatörler vardır. IGBT (İzole edilmiş kapılı, iki kutuplu transistör) MMA invertör teknolojisine sahiptir. Turbo fanlı sağlam sac gövdeden oluşmaktadır. Hafif, kompakt, düşük tüketime sahip ve güvenilirdir. LED termal koruma göstergesi mevcuttur.</p> <p>There is no motor coil winding, it works with the electronic card system. There are small copper-wound capacitors inside the machine. IGBT (Insulated gate, bipolar transistor) has MMA inverter technology. It consists of a solid sheet metal body with a turbo fan. It is light, compact, low consumption and reliable. There is an LED thermal protection indicator.</p> <p>Es gibt keine Motorspulenwicklung, es funktioniert mit dem elektronischen Kartensystem. In der Maschine befinden sich kleine kupfergewickelte Kondensatoren. IGBT (Insulated Gate, Bipolar Transistor) verfügt über MMA-Wechselrichtertechnologie. Er besteht aus einem massiven Blechkörper mit Turbogebälde. Es ist leicht, kompakt, verbrauchsarm und zuverlässig. Es gibt eine LED-Thermoschutzanzeige.</p>		



STANLEY JENERATÖR

GENERATOR

GENERATOR



Model Adı	SG3100B
Ses Seviyesi (dB)	96dB(A)
Frekans	50 Hz
Motor Gücü	7Hp
Motor Tipi	Tek Silindir, 4 zamanlı, Hava Soğutmalı
Genişlik	44,5 cm
Uzunluk (cm)	65 cm
Yükseklik	44,5 cm
Net Ağırlık	40 kg
Maksimum Çıkış Gücü	2,9 kW
Sürekli Çıkış Gücü	2,6 kW
Yakıt Tipi	Normal kurşunsuz benzin
Yakıt Kapasitesi	15 L
Yakıt Tüketimi	1253 g/h
Yağ Kapasitesi	0,6 L
Çalıştırma Şekli	İpli

Model Name	SG3100B
Generator type	Synchronous
Protection type	IP 23M
Continuous rated power Prated (S1)	2.6 kW
Maximum power Pmax	2.9 kW
Rated voltage U _{rated}	2 x 230 V~
Rated current I _{rated}	11.3 A
Frequency Frated	50 Hz
Drive engine design	Single-cylinder forced air-cooled 4-stroke OHV
Displacement	212 cm ³
Fuel type	Normal unleaded petrol
Tank capacity	15 L
Engine oil	Appox.0.6 l (15W40/<0 oC: 5W30)
Consumption at 2/3 load	1253 g/h
Weight	40 kg
Guaranteed sound power level LWA	96 dB(A)
Power class:	G1
Max. Temperature	40 °C
Max. altitude (above mean sea level)	1000 m
Spark plug	LDF7RTC
Box dimensions (LxWxH)	65,00 x 44,50 x 44,5 cm

STANLEY JENERATÖR

GENERATOR

GENERATOR



Model Adı	SG5600B
Ses Seviyesi (dB)	97dB(A)
Frekans	50 Hz
Motor Gücü	18Hp
Motor Tipi	Tek Silindir, 4 zamanlı, Hava Soğutmalı
Genişlik	53 cm
Uzunluk (cm)	74 cm
Yükseklik	55 cm
Net Ağırlık	82,5 kg
Maksimum Çıkış Gücü	3,3 kW (230V~)/5,5 kW (400V~)
Sürekli Çıkış Gücü	3 kW (230V~)/5 kW (400V~)
Yakıt Tipi	Normal kurşunsuz benzin
Yakıt Kapasitesi	25 L
Yakıt Tüketimi	2964 g/h
Yağ Kapasitesi	1.1 L
Çalıştırma Şekli	Elektrik Marşlı

Model Name	SG5600B
Generator type	Synchronous
Protection type	IP 23M
Continuous rated power Prated (S1)	3 kW (230V~)/5 kW (400V~)
Maximum power Pmax	3.3 kW (230V~)/5.5 kW (400V~)
Rated voltage Urated	2 x 230 V~ 1 x 400V 3~
Frequency Frated	50 Hz
Drive engine design	Single-cylinder forced air-cooled 4-stroke OHV
Displacement	458 cm ³
Fuel type	Normal unleaded petrol
Tank capacity	25 L
Engine oil	Appox. 1.1 L (15W40/<0 oC: 5W30)
Net weight	82.5 kg
Guaranteed sound power level LWA	97 dB(A)
Power class	G1
Max. Temperature	40 °C
Spark plug	LD F7RTC
Box dimensions (LxWxH)	74,00 x 53,00 x 55 cm

STANLEY JENERATÖR

GENERATOR

GENERATOR



Model Adı	SG7500B
Ses Seviyesi (dB)	97dB(A)
Frekans	50 Hz
Motor Gücü	18Hp
Motor Tipi	Tek Silindir, 4 zamanlı, Hava Soğutmalı
Genişlik	53 cm
Uzunluk (cm)	74 cm
Yükseklik	55 cm
Net Ağırlık	88 kg
Maksimum Çıkış Gücü	3,3 kW (230 V~)/ 7,5 kW (400 V 3~)
Sürekli Çıkış Gücü	3,0 kW (230 V~)/ 7,0 kW (400 V 3~)
Yakıt Tipi	Normal kurşunsuz benzin
Yakıt Kapasitesi	25 L
Yakıt Tüketimi	3432g/h
Yağ Kapasitesi	1.1 L
Çalıştırma Şekli	Elektrik Marşlı

Model Name	SG7500B
Generator type:	Synchronous
Protection type:	IP 23M
Continuous rated power Prated (S1):	3.0 kW (230 V~)/ 7.0 kW (400 V 3~)
Maximum power Pmax:	3.3 kW (230 V~)/ 7.5 kW (400 V 3~)
Rated voltage Urated:	2 x 230 V~ 1 x 400V 3~
Frequency Frated:	50 Hz
Drive engine design:	Single-cylinder forced air-cooled 4-stroke OHV
Displacement:	458 cm ³
Fuel type: N	Normal unleaded petrol
Tank capacity:	25 L
Engine oil:	Appox. 1.1 l (15W40/<0 oC: 5W30)
Gross weight:	96.5 Kg
Net weight:	88 Kg
Guaranteed sound power level LWA:	97 dB(A)
Power class:	G1
Max. temperature:	40 °C
Spark plug:	LD F7RTC
Box dimensions (LxWxH):	74,00 x 53,00 x 55 cm

12V 2.0AH LI-ION ÇİFT AKÜLÜ MATKAP

DCD710D2

Akü Voltajı	12V
Akü Tipi	Li-Ion
Akü Kapasitesi	2.0 Ah
Maksimum Tork (Yumuşak/Sert)	15 / 24 Nm
Yüksüz Hızı	0-400/1500 dev/dak.
Mandren Kapasitesi	1-10 mm
Maksimum Delme Kapasitesi [Ahşap / Metal]	20 / 10 mm
Ağırlık	1.1 kg
Uzunluk x Yükseklik	185 x 195 mm



12V 2.0AH LI-ION KÖMÜRSÜZ ÇİFT AKÜLÜ KOMPAKT MATKAP

DCD701D2

Akü Voltajı	12V
Akü Tipi	Li-ion
Akü Kapasitesi	2.0 Ah
Maksimum Tork (Yumuşak)	25.5 Nm
Maksimum Tork (Sert)	57.5 Nm
Yüksüz Hızı	0-425 / 0-1500 dev/dak.
Mandren Kapasitesi	10 mm
Maksimum Delme Kapasitesi (Ahşap)	20 mm
Maksimum Delme Kapasitesi (Metal)	10 mm
Ağırlık	1 kg (batarya hariç)
Uzunluk x Yükseklik	152 x 185 mm



12V 2.0AH LI-ION ÇİFT AKÜLÜ KÖMÜRSÜZ DARBELİ TORNAVİDA

DCF801D2

Akü Voltajı	12V
Akü Tipi	Li-ion
Akü Kapasitesi	2.0 Ah
Maksimum Tork	163 Nm
Yüksüz Hızı	0-950/1950/2850 dev/dak.
Darbe oranı	0-3600 dar/dak.
Uç Tutucu	6.35 mm
Ağırlık	0.8 kg (batarya hariç)
Uzunluk x Yükseklik	125 x 188 mm



18V 1.5AH LI-ION ÇİFT AKÜLÜ DARBESİZ MATKAP

DCD771S2

Akü Voltajı	18V
Akü Tipi	Li-ion
Akü Kapasitesi	1.5 Ah
Maksimum Tork (Sert)	42 Nm
Maksimum Tork (Yumuşak)	24 Nm
Yüksüz Hızı	0-450/1500 dev/dak.
Mandren Kapasitesi	1.5-13 mm
Maksimum Delme Kapasitesi [Ahşap / Metal]	30/13 mm
Ağırlık	1.65 kg
Uzunluk x Yükseklik	219 x 191 mm



18V 1.5AH LI-ION KÖMÜRSÜZ ÇİFT AKÜLÜ DARBESİZ MATKAP

DCD777S2T

Akü Voltajı	18V
Akü Tipi	Li-ion
Akü Kapasitesi	1.5 Ah
Maksimum Tork (Sert)	65 Nm
Maksimum Tork (Yumuşak)	26 Nm
Yüksüz Hızı	0-500/1750 dev/dak.
Mandren Kapasitesi	1.5-13 mm
Maksimum Delme Kapasitesi [Ahşap / Metal]	30/13 mm
Ağırlık	1.5 kg
Uzunluk x Yükseklik	192 x 198 mm



18V 2.0AH LI-ION KOMPAKT KÖMÜRSÜZ ÇİFT AKÜLÜ DARBESİZ MATKAP

DCD708D2T

Akü Voltajı	18V
Akü Tipi	Li-ion
Akü Kapasitesi	2.0 Ah
Maksimum Tork (Sert)	65 Nm
Maksimum Tork (Yumuşak)	26 Nm
Yüksüz Hızı	0-450/1650 dev/dak.
Mandren Kapasitesi	1.5-13 mm
Maksimum Delme Kapasitesi [Ahşap / Metal]	35/13 mm
Ağırlık	1.45 kg
Uzunluk x Yükseklik	160 x 198 mm



18V 2.0AH LI-ION KÖMÜRSÜZ ÇİFT AKÜLÜ DARBESİZ MATKAP

DCD800D2T

Akü Voltajı	18V
Akü Tipi	Li-ion
Akü Kapasitesi	2.0 Ah
Maksimum Tork (Yumuşak)	27 Nm
Maksimum Tork (Sert)	90 Nm
Yüksüz Hızı	0-650/ 0-2000 dev/dak.
Mandren Kapasitesi	13 mm
Maksimum Delme Kapasitesi (Ahşap)	55 mm
Maksimum Delme Kapasitesi (Metal)	13 mm
Ağırlık	1.28 kg (batarya hariç)
Uzunluk x Yükseklik	163,8 x 205,7 mm



18V 5.0AH LI-ION KÖMÜRSÜZ ÇİFT AKÜLÜ DARBESİZ MATKAP

DCD791P2

Akü Voltajı	18V
Akü Tipi	Li-ion
Akü Kapasitesi	5.0 Ah
Maksimum Tork (Sert)	70 Nm
Maksimum Tork (Yumuşak)	27 Nm
Yüksüz Hızı	0-550/2000 dev/dak.
Mandren Kapasitesi	1.5-13 mm
Maksimum Delme Kapasitesi [Ahşap / Metal]	40/13 mm
Ağırlık	1.72 kg
Uzunluk x Yükseklik	173 x 203 mm



18V 5.0AH LI-ION KÖMÜRSÜZ ÇİFT AKÜLÜ DARBESİZ MATKAP

DCD800P2T

Akü Voltajı	18V
Akü Tipi	Li-ion
Akü Kapasitesi	5.0 Ah
Maksimum Tork (Yumuşak)	27 Nm
Maksimum Tork (Sert)	90 Nm
Yüksüz Hızı	0-650/ 0-2000 dev/dak.
Mandren Kapasitesi	13 mm
Maksimum Delme Kapasitesi (Ahşap)	55 mm
Maksimum Delme Kapasitesi (Metal)	13 mm
Ağırlık	1.28 kg (batarya hariç)
Uzunluk x Yükseklik	163,8 x 205,7 mm



18V 1.5AH LI-ION ÇİFT AKÜLÜ DARBELİ MATKAP

DCD776S2

Akü Voltajı	18V
Akü Tipi	Li-Ion
Akü Kapasitesi	1.5 Ah
Maksimum Tork (Sert)	42 Nm
Maksimum Tork (Yumuşak)	24 Nm
Yüksüz Hızı	0-400/1500 dev/dak.
Darbe Oranı	0-7650/25500 dar/dak.
Mandren Kapasitesi	1.5-13 mm
Maks. Delme Kap. [Ahşap / Metal/ Duvar]	30/13/13 mm
Ağırlık	1.7 kg
Uzunluk x Yükseklik	228 x 191 mm



18V 2.0AH LI-ION KOMPAKT KÖMÜRSÜZ ÇİFT AKÜLÜ DARBELİ MATKAP

DCD709D2T

Akü Voltajı	18V
Akü Tipi	Li-Ion
Akü Kapasitesi	2.0 Ah
Maksimum Tork (Sert)	65 Nm
Maksimum Tork (Yumuşak)	26 Nm
Yüksüz Hızı	0-450/1650 dev/dak.
Darbe Oranı	0-28050 dar/dak.
Mandren Kapasitesi	1.5-13 mm
Maks. Delme Kap. [Ahşap / Metal/ Duvar]	30/13/13 mm
Ağırlık	1.5 kg
Uzunluk x Yükseklik	175 x 198 mm



18V 2.0AH LI-ION KÖMÜRSÜZ ÇİFT AKÜLÜ DARBELİ MATKAP

DCD796D2

Akü Voltajı	18V
Akü Tipi	Li-Ion
Akü Kapasitesi	2.0 Ah
Maksimum Tork (Sert)	70 Nm
Maksimum Tork (Yumuşak)	27 Nm
Yüksüz Hızı	0-550/2000 dev/dak.
Darbe Oranı	0-9350/34000 dar/dak.
Mandren Kapasitesi	1.5-13 mm
Maks. Delme Kap. [Ahşap / Metal/ Duvar]	40/13/13 mm
Ağırlık	1.60 kg
Uzunluk x Yükseklik	190 x 203 mm



18V 2.0AH LI-ION KÖMÜRSÜZ ÇİFT AKÜLÜ DARBELİ MATKAP

DCD805D2T

Akü Voltajı	18V
Akü Tipi	Li-ion
Akü Kapasitesi	2.0 Ah
Maksimum Tork (Yumuşak)	27 Nm
Maksimum Tork (Sert)	90 Nm
Yüksüz Hızı	0-650/ 0-2000 dev/dak.
Darbe Oranı	11.050/34.000 dar/dak.
Mandren Kapasitesi	13 mm
Maksimum Delme Kapasitesi (Ahşap)	55 mm
Maksimum Delme Kapasitesi (Metal)	13 mm
Maksimum Delme Kapasitesi (Duvar)	13 mm
Ağırlık	1.34 kg (batarya hariç)
Uzunluk x Yükseklik	177,8 x 205,7 mm



18V 1.7AH LI-ION POWER STACK KÖMÜRSÜZ ÇİFT AKÜLÜ DARBELİ MATKAP

DCD805E2T

Akü Voltajı	18V
Akü Tipi	Li-ion
Akü Kapasitesi	1.7 Ah Power Stack
Maksimum Tork (Yumuşak)	27 Nm
Maksimum Tork (Sert)	90 Nm
Yüksüz Hızı	0-650/ 0-2000 dev/dak.
Darbe Oranı	11.050 / 34.000 dar/dak.
Mandren Kapasitesi	13 mm
Maksimum Delme Kapasitesi (Ahşap)	55 mm
Maksimum Delme Kapasitesi (Metal)	13 mm
Maksimum Delme Kapasitesi (Duvar)	13 mm
Ağırlık	1.34 kg (batarya hariç)
Uzunluk x Yükseklik	177,8 x 205,7 mm



18V 5.0AH LI-ION KÖMÜRSÜZ ÇİFT AKÜLÜ DARBELİ MATKAP

DCD796P2

Akü Voltajı	18V
Akü Tipi	Li-ion
Akü Kapasitesi	5.0 Ah
Maksimum Tork (Sert)	70 Nm
Maksimum Tork (Yumuşak)	27 Nm
Yüksüz Hızı	0-550/2000 dev/dak.
Darbe Oranı	0-9350/34000 dar/dak.
Mandren Kapasitesi	1.5-13 mm
Maks. Delme Kap. [Ahşap / Metal/ Duvar]	40/13/13 mm
Ağırlık	1.82 kg
Uzunluk x Yükseklik	190 x 203 mm



18V 5.0AH LI-ION KÖMÜRSÜZ ÇİFT AKÜLÜ DARBELİ MATKAP

DCD805P2T

Akü Voltajı	18V
Akü Tipi	Li-ion
Akü Kapasitesi	5.0 Ah
Maksimum Tork (Yumuşak)	27 Nm
Maksimum Tork (Sert)	90 Nm
Yüksüz Hızı	0-650/ 0-2000 dev/dak.
Darbe Oranı	11.050 / 34.000 dar/dak.
Mandren Kapasitesi	13mm
Maksimum Delme Kapasitesi (Ahşap)	55mm
Maksimum Delme Kapasitesi (Metal)	13mm
Maksimum Delme Kapasitesi (Duvar)	13mm
Ağırlık	1.34 kg (batarya hariç)
Uzunluk x Yükseklik	177,8 x 205,7 mm



18V 2.0AH LI-ION KÖMÜRSÜZ ÇİFT AKÜLÜ DARBELİ TORNAVİDA

DCF887D2

Akü Voltajı	18V
Akü Tipi	Li-ion
Akü Kapasitesi	2.0 Ah
Maksimum Tork	205 Nm
Yüksüz Hızı	0-1000/2800/3250 dev/dak.
Darbe Oranı	0 - 3800 dar/dak.
Maksimum Somun Çapı	M14
Uç Tutucu	6.35 mm (1/4")
Ağırlık	1.35 kg
Uzunluk x Yükseklik	134 x 245 mm



18V 2.0AH LI-ION KÖMÜRSÜZ ÇİFT AKÜLÜ DARBELİ TORNAVİDA

DCF850D2T

Akü Voltajı	18V
Akü Tipi	Li-ion
Akü Kapasitesi	2.0 Ah
Maksimum Tork	206 Nm
Yüksüz Hızı	0-1.000/2.800/3.250 dev/dak.
Darbe Oranı	0-3800 dar/dak.
Uç Tutucu	6.35 mm
Ağırlık	0,9 kg (batarya hariç)
Uzunluk x Yükseklik	101 x 210 mm



18V 1.7AH LI-ION POWER STACK KÖMÜRSÜZ ÇİFT AKÜLÜ DARBELİ TORNAVİDA

DCF850E2T-QW

Akü Voltajı	18V
Akü Tipi	Li-ion
Akü Kapasitesi	1.7 Ah Power Stack
Maksimum Tork (Yumuşak)	206 Nm
Yüksüz Hızı	0 – 1.000 / 2.800 / 3.250 dev/dak.
Darbe Oranı	0–3800 dar/dak.
Uç Tutucu	6.35 mm
Ağırlık	0,9 kg (batarya hariç)
Uzunluk x Yükseklik	101 x 210 mm



DEWALT POWER STACK



18V 3.0AH LI-ION KOMPAKT KÖMÜRSÜZ ÇİFT AKÜLÜ DARBELİ TORNAVİDA

DCF809L2T

Akü Voltajı	18V
Akü Tipi	Li-ion
Akü Kapasitesi	3.0 Ah
Maksimum Tork	190 Nm
Yüksüz Hızı	0-2800 dev/dak.
Darbe Oranı	0 - 3200 dar/dak.
Maksimum Somun Çapı	M12
Uç Tutucu	6.35 mm (1/4")
Ağırlık	1.25 kg
Uzunluk x Yükseklik	130 x 236 mm



18V 2.0AH LI-ION KOMPAKT KÖMÜRSÜZ ÇİFT AKÜLÜ DARBELİ TORNAVİDA

DCF840D2T

Akü Voltajı	18V
Akü Tipi	Li-ion
Akü Kapasitesi	2.0 Ah
Maksimum Tork	192 Nm
Yüksüz Hızı	0-3200 dev/dak.
Uç Tutucu	6.35 mm
Darbe Oranı	0-4200 dar/dak.
Ağırlık	0,88 kg (batarya hariç)
Uzunluk x Yükseklik	129mm X 210 mm



18V 5.0AH LI-ION KÖMÜRSÜZ ÇİFT AKÜLÜ DARBELİ TORNAVİDA

DCF887P2

Akü Voltajı	18V
Akü Tipi	Li-Ion
Akü Kapasitesi	5.0 Ah
Maksimum Tork	205 Nm
Yüksüz Hızı	0-1000/2800/3250 dev/dak.
Darbe Oranı	0 - 3800 dar/dak.
Maksimum Somun Çapı	M14
Uç Tutucu	6.35 mm (1/4")
Ağırlık	1.52 kg
Uzunluk x Yükseklik	134 x 245 mm



18V 5.0AH LI-ION KÖMÜRSÜZ ÇİFT AKÜLÜ DARBELİ TORNAVİDA

DCF850P2T

Akü Voltajı	18V
Akü Tipi	Li-ion
Akü Kapasitesi	5.0 Ah
Maksimum Tork	192 Nm
Yüksüz Hızı	0-3200 dev/dak.
Uç Tutucu	6.35 mm
Darbe Oranı	0-4200 dar/dak.
Ağırlık	0,88 kg (batarya hariç)
Uzunluk x Yükseklik	129mm X 210 mm



18V 4.0AH 125MM LI-ION ÇİFT AKÜLÜ AVUÇ TAŞLAMA

DCG412M2

Akü Voltajı	18V
Akü Tipi	Li-Ion
Akü Kapasitesi	4.0 Ah
Disk Çapı	125 mm
Mil Bağlantısı	M14
Tetik Tipi	Altan Tetik
Yüksüz Hızı	7000 dev/dak.
Ağırlık	2.5 kg
Uzunluk x Yükseklik	400 x 125 mm



18V 6.0AH 125MM LI-ION FLEXVOLT ADV. AVUÇ TAŞLAMA

DCG409T1

Akü Voltajı	18V
Akü Tipi	Li-ion
Akü Kapasitesi	6.0 Ah
Disk Çapı	125 mm
Mil Bağlantısı	M14
Tetik Tipi	Yandan Tetik
Yüksüz Hızı	9000 dev/dak.
Ağırlık	1,81 kg
Uzunluk x Yükseklik	382,09 x 130,025 mm



18V 4.0AH LI-ION KÖMÜRSÜZ SDS-PLUS PNÖMATİK MATKAP

DCH133M1

Akü Voltajı	18V
Akü Tipi	Li-Ion
Akü Kapasitesi	4.0 Ah
Uç Tutucu	SDS-Plus
Maksimum Darbe Gücü	2.8 J
Darbe Gücü (EPTA 05/2009)	2.6 J
Yüksüz Hızı	0-1500 dev/dak.
Darbe Oranı	0-5500 dar/dak.
Optimum Delme Kapasitesi [Betonda]	4-14 mm
Maks. Delme Kap. [Beton/ Ahşap / Metal]	26/30/13 mm
Keski / Oyma Modu	Evet
Ağırlık	2.9 kg
Uzunluk x Yükseklik	383 x 161 mm
Vibrasyon Değeri	14.5 m/s ²



18V 4.0AH LI-ION ÇİFT AKÜLÜ SDS-PLUS PNÖMATİK MATKAP

DCH253M2

Akü Voltajı	18V
Akü Tipi	Li-Ion
Akü Kapasitesi	4.0 Ah
Uç Tutucu	SDS-Plus
Maksimum Darbe Gücü	2.4 J
Darbe Gücü (EPTA 05/2009)	2.1 J
Yüksüz Hızı	0-1200 dev/dak.
Darbe Oranı	0-4500 dar/dak.
Optimum Delme Kapasitesi [Betonda]	4-12 mm
Maks. Delme Kap. [Beton/ Ahşap / Metal]	24/26/13 mm
Keski / Oyma Modu	Evet
Ağırlık	3.1 kg
Uzunluk x Yükseklik	301 x 202 mm
Vibrasyon Değeri	6.6 m/s ²



550W 10MM DARBESİZ MATKAP

DWD014S

Giriş Gücü	550W
Mandren Kapasitesi	10 mm
Yüksüz Hızı	0-2800 dev/dak.
Maksimum Tork	7.9 Nm
Maksimum Delme Kapasitesi [Ahşap]	25 mm
Maksimum Delme Kapasitesi [Metal]	10 mm
Mil Bağlantısı	1/2" x 20 U.N.F
Ağırlık	1.34 kg
Uzunluk x Yükseklik	225 x 170 mm



701W 10MM DARBESİZ MATKAP

DWD112S

Giriş Gücü	701W
Mandren Kapasitesi	10 mm
Yüksüz Hızı	0-2500 dev/dak.
Maksimum Tork	10.9 Nm
Maksimum Delme Kapasitesi [Ahşap]	25 mm
Maksimum Delme Kapasitesi [Metal]	10 mm
Mil Bağlantısı	1/2" x 20 U.N.F
Ağırlık	1.8 kg
Uzunluk x Yükseklik	230 x 190 mm



701W 13MM DARBELİ MATKAP

DWD024

Giriş Gücü	750W
Mandren Kapasitesi	13 mm
Yüksüz Hızı	0-2800 dev/dak.
Darbe Oranı	47600 dar/dak.
Maksimum Tork	8.6 Nm
Maksimum Delme Kapasitesi [Ahşap]	25 mm
Maksimum Delme Kapasitesi [Metal]	13 mm
Maksimum Delme Kapasitesi [Beton]	16 mm
Ağırlık	1.82 kg
Uzunluk x Yükseklik	255 x 180 mm



701W 13MM DARBELİ MATKAP

DWD024KS

Giriş Gücü	750W
Mandren Kapasitesi	13 mm
Yüksüz Hızı	0-2800 dev/dak.
Darbe Oranı	47600 dar/dak.
Maksimum Tork	8.6 Nm
Maksimum Delme Kapasitesi [Ahşap]	25 mm
Maksimum Delme Kapasitesi [Metal]	13 mm
Maksimum Delme Kapasitesi [Beton]	16 mm
Ağırlık	1.82 kg
Uzunluk x Yükseklik	255 x 180 mm



540W 6.3MM ELEKTRİKLİ TORNAVİDA

DW268K

Giriş Gücü	540W
Maksimum Tork	4-26 Nm
Yüksüz Hızı	0-2500 dev/dak.
Maksimum Vida Çapı	6.3 mm
Uç Tutucu	6.35 mm (Hex)
Ağırlık	1.3 kg
Uzunluk x Yükseklik	301 x 187 mm



710W 1/2" SOMUN SIKMA MAKİNESİ

DW292

Giriş Gücü	710W
Maksimum Tork	440 Nm
Yüksüz Hızı	2200 dev/dak.
Darbe Oranı	2700 dar/dak.
Ağırlık	3.2 kg
Uzunluk x Yükseklik	292 x 216 mm



710W 3/4" SOMUN SIKMA MAKİNESİ

DW294

Giriş Gücü	710W
Maksimum Tork	440 Nm
Yüksüz Hızı	2200 dev/dak.
Darbe Oranı	2700 dar/dak.
Ağırlık	3.2 kg
Uzunluk x Yükseklik	292 x 216 mm



800W 26MM 3.0J SDS-PLUS PNÖMATİK MATKAP

D25133K

Giriş Gücü	800W
Maksimum Darbe Gücü	2.8 J
Darbe Gücü (EPTA 05/2009)	2.6 J
Yüksüz Hızı	0-1500 dev/dak.
Darbe Oranı	0-5500 dar/dak.
Optimum Delme Kapasitesi [Beton]	4-14 mm
Maksimum Delme Kapasitesi [Beton]	26 mm
Maks. Delme Kap. [Buat / Ahşap / Metal]	50/30/13 mm
Çalışma Modu	Kırma / Darbeli Delme / Delme
Ağırlık	2.6 kg
Uzunluk x Yükseklik	335 x 210 mm
Vibrasyon Değeri	15.4 m/s ²



900W 28MM 3.0J SDS-PLUS PNÖMATİK MATKAP

D25143K

Giriş Gücü	900W
Maksimum Darbe Gücü	3.2 J
Darbe Gücü (EPTA 05/2009)	3.0 J
Yüksüz Hızı	0-1450 dev/dak.
Darbe Oranı	0-5350 dar/dak.
Optimum Delme Kapasitesi [Beton]	4-18 mm
Maksimum Delme Kapasitesi [Beton]	28 mm
Maks. Delme Kap. [Buat / Ahşap / Metal]	65/30/13 mm
Çalışma Modu	Kırma / Darbeli Delme / Delme
Ağırlık	3.0 kg
Uzunluk x Yükseklik	340 x 210 mm
Vibrasyon Değeri	14.9 m/s ²



950W 30MM 3.5J SDS-PLUS PNÖMATİK MATKAP

D25334K

Giriş Gücü	950W
Maksimum Darbe Gücü	4.2 J
Darbe Gücü (EPTA 05/2009)	3.5 J
Yüksüz Hızı	0-1150 dev/dak.
Darbe Oranı	0-5200 dar/dak.
Optimum Delme Kapasitesi [Beton]	6-20 mm
Maksimum Delme Kapasitesi [Beton]	30 mm
Maks. Delme Kap. [Buat / Ahşap / Metal]	65/30/13 mm
Çalışma Modu	Kırma / Darbeli Delme / Delme
Ağırlık	3.9 kg
Uzunluk x Yükseklik	375 x 250 mm
Vibrasyon Değeri	6.9 m/s ²



730W 115MM NO-VOLT AVUÇ TAŞLAMA

DWE4016

Giriş Gücü	730W
Disk Çapı	115 mm
Tetik Tipi	Yandan Tetik
Yüksüz Hızı	11000 dev/dak.
Mil Bağlantısı	M14
Ağırlık	2.0 kg
Uzunluk x Yükseklik	270 x 80 mm



800W 115MM NO-VOLT AVUÇ TAŞLAMA

DWE4056

Giriş Gücü	800W
Disk Çapı	115 mm
Tetik Tipi	Yandan Tetik
Yüksüz Hızı	11800 dev/dak.
Mil Bağlantısı	M14
Ağırlık	1.8 kg
Uzunluk x Yükseklik	270 x 80 mm



900W 115MM NO-VOLT AVUÇ TAŞLAMA

DWE4156

Giriş Gücü	900W
Disk Çapı	115 mm
Tetik Tipi	Yandan Tetik
Yüksüz Hızı	11800 dev/dak.
Mil Bağlantısı	M14
Ağırlık	2.0 kg
Uzunluk x Yükseklik	270 x 80 mm



1400W 125MM NO-VOLT AVUÇ TAŞLAMA

DWE4237

Giriş Gücü	1400W
Disk Çapı	125 mm
Tetik Tipi	Yandan Tetik
Yüksüz Hızı	11500 dev/dak.
Mil Bağlantısı	M14
Ağırlık	2.2 kg
Uzunluk x Yükseklik	285 x 80 mm



2200W 180MM BÜYÜK TAŞLAMA

DWE493

Giriş Gücü	2200W
Disk Çapı	180 mm
Tetik Tipi	Altan Tetik
Yüksüz Hızı	8500 dev/dak.
Mil Bağlantısı	M14
Ağırlık	5.1 kg
Uzunluk x Yükseklik	484 x 112 mm



2600W 180MM BÜYÜK TAŞLAMA

DWE497

Giriş Gücü	2600W
Disk Çapı	180 mm
Tetik Tipi	Aİttan Tetik
Yüksüz Hızı	8500 dev/dak.
Mil Bağlantısı	M14
Ağırlık	5.4 kg
Uzunluk x Yükseklik	490 x 145 mm



2200W 230MM BÜYÜK TAŞLAMA

DWE492

Giriş Gücü	2200W
Disk Çapı	230 mm
Tetik Tipi	Aİttan Tetik
Yüksüz Hızı	6600 dev/dak.
Mil Bağlantısı	M14
Ağırlık	5.2 kg
Uzunluk x Yükseklik	490 x 151 mm



2400W 230MM BÜYÜK TAŞLAMA

DWE4559

Giriş Gücü	2400W
Disk Çapı	230 mm
Tetik Tipi	Aİttan Tetik
Yüksüz Hızı	6500 dev/dak.
Mil Bağlantısı	M14
Ağırlık	5.7 kg
Uzunluk x Yükseklik	520 x 145 mm



2600W 230MM BÜYÜK TAŞLAMA

DWE4579

Giriş Gücü	2600W
Disk Çapı	230 mm
Tetik Tipi	Alttan Tetik
Yüksüz Hızı	6500 dev/dak.
Mil Bağlantısı	M14
Aşın Yük Koruması	Evet
Ağırlık	5.9 kg
Uzunluk x Yükseklik	520 x 145 mm



1500W 190MM DAİRE TESTERE

DWE5615

Giriş Gücü	1500W
Yüksüz Hızı	5500 dev/dak.
Bıçak Çapı	190 mm
Bıçak Göbek Çapı	30 mm
Maksimum Kesme Derinliği 90°	68 mm
Maksimum Kesme Derinliği 45°	48 mm
Ağırlık	4.0 kg



1750W 235X30MM DAİRE TESTERE

D23700

Giriş Gücü	1750W
Yüksüz Hızı	4700 dev/dak.
Bıçak Çapı	235 mm
Bıçak Göbek Çapı	30 mm
Maksimum Kesme Derinliği 90°	86 mm
Maksimum Kesme Derinliği 45°	62 mm
Ağırlık	8.2 kg
Uzunluk x Yükseklik	430 x 290 mm



18V 2.0AH V20 LİTYUM ÇİFT AKÜLÜ KÖMÜRSÜZ DARBELİ MATKAP

SBD715D2K

Akü Voltajı	18V
Akü Tipi	V20 Li-ion
Akü Kapasitesi	2.0 Ah
Darbe Oranı	0-32300 dar/dak.
Maksimum Tork (Sert)	60 Nm
Yüksüz Hızı	0-600/0-1.900 dev/dak.
Mandren Kapasitesi	13 mm
Maks. Delme Kapasitesi (Ahşap)	30 mm
Maks. Delme Kapasitesi (Metal)	13 mm
Maks. Delme Kapasitesi (Duvar)	13 mm
Koli Adedi	3
Ağırlık	1.5 kg (batarya hariç)



V20
LITHIUM ION

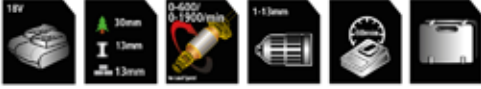

18V 2.0AH V20 LİTYUM ÇİFT AKÜLÜ DARBELİ MATKAP

SCD718D2K

Akü Voltajı	18V
Akü Tipi	V20 Li-ion
Akü Kapasitesi	2.0 Ah
Maksimum Tork	50 Nm
Yüksüz Hızı	0-400/1.500 dev/dak.
Mandren Kapasitesi	13 mm
Maks. Delme Kapasitesi (Ahşap)	35 mm
Maks. Delme Kapasitesi (Metal)	13 mm
Koli Adedi	3
Ağırlık	1.3 kg (batarya hariç)



V20
LITHIUM ION

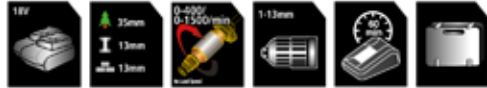

18V V20 KÖMÜRSÜZ DARBELİ MATKAP (AKÜSÜZ)

SBD715B

Akü Voltajı	18V
Akü Tipi	V20 Li-ion
Akü Kapasitesi	Aküsz
Darbe Oranı	0-32300 dar/dak.
Maksimum Tork (Sert)	60 Nm
Yüksüz Hızı	0-600/0-1.900 dev/dak.
Mandren Kapasitesi	13 mm
Maks. Delme Kapasitesi (Ahşap)	30 mm
Maks. Delme Kapasitesi (Metal)	13 mm
Maks. Delme Kapasitesi (Duvar)	13 mm
Ağırlık	1.5 kg



V20
LITHIUM ION

18V 1.5AH V20 LİTYUM ÇİFT AKÜLÜ KÖMÜRSÜZ DARBESİZ MATKAP

SBD710C2K

Akü Voltajı	18V
Akü Tipi	V20 Li-ion
Akü Kapasitesi	1.5 Ah
Maksimum Tork	60 Nm
Yüksüz Hızı	0-600/1900 dev/dak.
Mandren Kapasitesi	13 mm
Maks. Delme Kapasitesi (Ahşap)	35 mm
Maks. Delme Kapasitesi (Metal)	13 mm
Koli Adedi	3
Ağırlık	1.2 kg (batarya hariç)



V20
LITHIUM ION

18V 1.5AH V20 LİTYUM ÇİFT AKÜLÜ KÖMÜRSÜZ DARBELİ MATKAP

SBD715C2K

Akü Voltajı	18V
Akü Tipi	V20 Li-ion
Akü Kapasitesi	1.5 Ah
Maksimum Tork	60 Nm
Yüksüz Hızı	0-600 / 0-1.900 dev/dak.
Mandren Kapasitesi	13 mm
Maks. Delme Kapasitesi (Ahşap)	30 mm
Maks. Delme Kapasitesi (Metal)	13 mm
Maks. Delme Kapasitesi (Duvar)	13 mm
Koli Adedi	3
Ağırlık	1.2 kg (batarya hariç)



V20
LITHIUM ION

18V 1.5AH V20 LİTYUM ÇİFT AKÜLÜ DARBELİ MATKAP

SCD711C2K

Akü Voltajı	18V
Akü Tipi	V20 Li-ion
Akü Kapasitesi	1.5 Ah
Maksimum Tork	50 Nm
Yüksüz Hızı	0 - 400 / 1.500 dev/dak.
Mandren Kapasitesi	13 mm
Maks. Delme Kapasitesi (Ahşap)	35 mm
Maks. Delme Kapasitesi (Metal)	13 mm
Koli Adedi	3
Ağırlık	1.3 kg (batarya hariç)

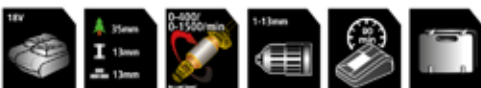

V20
LITHIUM ION

18V 2.0AH V20 LİTYUM ÇİFT AKÜLÜ DARBESİZ MATKAP

SCD700D2K

Akü Voltajı	18V
Akü Tipi	V20 Li-ion
Akü Kapasitesi	2.0 Ah
Maksimum Tork	50 Nm
Yüksüz Hızı	0-400 /1.500 dev/dak.
Mandren Kapasitesi	13 mm
Maks. Delme Kapasitesi (Ahşap)	35 mm
Maks. Delme Kapasitesi (Metal)	13 mm
Koli Adedi	4
Ağırlık	1.2 kg (batarya hariç)



V20
LITHIUM ION

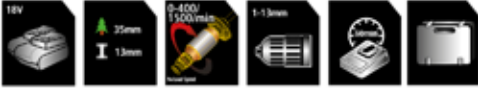

1600W 190MM DAİRE TESTERE

SC16

Giriş Gücü	1600 W
Yüksüz Hızı	5500 dev/dak
Testere Çapı	190 mm
Testere Delik Çapı	20/30 mm
Açı Kapasitesi	45°
Maks. Kesme Kapasitesi 90°	65 mm
Maks. Kesme Kapasitesi 45°	50 mm
Koli Adedi	2
Ağırlık	3.9 kg



1650W 254MM GÖNYE TESTERE

SM16

Giriş Gücü	1650W
Yüksüz Hızı	4800 dev/dak.
Bıçak Kalınlığı	2.8 mm
Bıçak Çapı	254 X 30 mm
Gönye Kapasitesi (sağ/sol)	52°/47°
Eğim Kapasitesi (sağ/sol)	0°/45°
Koli Adedi	1
Ağırlık	10.5 kg



1800W 254MM GÖNYE TESTERE

SM18

Giriş Gücü	1800W
Yüksüz Hızı	4800 dev/dak
Bıçak Kalınlığı	2.8 mm
Bıçak Çapı	254 X 30 mm
Gönye Kapasitesi (sağ/sol)	52°/47°
Eğim Kapasitesi (sağ/sol)	45°/45°
Koli Adedi	1
Ağırlık	18.6 kg



1200W 32CM ÇİM KESME MAKİNESİ

BEMW451

Güç	1200W
Kesme Geniřliđi	32cm
Çim Toplama Kapasitesi	35L
Yüksüz Hız	3500 dev/dak.
Ağırlık	9.35kg



1200W 32CM ÇİM KESME MAKİNESİ

BEMW451BH

Güç	1200 W
Kesme Geniřliđi	32cm
Çim Toplama Kapasitesi	35L
Yüksüz Hız	3500 dev/dak



1400W 34CM ÇİM KESME MAKİNESİ

BEMW461BH

Güç	1400 W
Kesme Geniřlięi	34cm
Çim Toplama Kapasitesi	40L
Yüksüz Hız	3500 dev/dak



1600W 38CM ÇİM KESME MAKİNESİ

BEMW471BH

Güç	1600 W
Kesme Geniřlięi	38cm
Çim Toplama Kapasitesi	45L
Yüksüz Hız	3500 dev/dak



STD İŞ GÜVENLİĞİ

BARET

HELMET

HELM



Ürün Özellikleri

MALZEME	ABS
YAPISI	SERT
ÖLÇÜLERİ	52-62CM
KOLİ MİKTARI	40 ADET
STANDARD	CE EN397
RENK	BEYAZ, KIRMIZI, MAVİ, SARI
Renk Kullanım Standartları	
Beyaz	Mühendis, teknisyenler ve ziyaretçiler için
Kırmızı	İş güvenlikçiler için
Sarı	İşçiler için
Mavi	Ustabaşları için

Product Properties

MATERIAL	ABS
STRUCTURE	HARD
DIMENSIONS	52-62CM
BOX QUANTITY	40 PCS
STANDARD	CE EN397
COLOUR	WHITE, RED, BLUE, YELLOW
Color Usage Standards	
White	For engineers, technicians and visitors
Red	For job security
Yellow	For workers
Blue	For foremen

Produkt Eigenschaften



MATERIAL	ABS
STRUKTUR	SCHWER
MASSE	52-62CM
KASTENMENGE	40 ST
STANDARD	CE EN397
FARBE	WEISS, ROT, BLAU, GELB
Farbverwendungsstandards	
Weiß	Für Ingenieure, Techniker und Besucher
Rot	Zur Arbeitsplatzsicherheit
Gelb	Für Arbeitnehmer
Blau	Für Vorarbeiter

KAYNAK BAŞLIKLARI



WELD HEAD PROTECTION

SCHWEISSKOPFSCHUTZ

Ürün Özellikleri

ÇEŞİTLERİ	<p>Elektrik ark kaynağı için kendinden kararan camlı başlık 9'dan 13'e koruma MIG, MAG, TIG ve PLAZMA KAYNAK düşük yoğunluk ve alevli kaynak için kullanılır.</p>	
	<p>Elektrik ark kaynağı için kendinden kararan camlı başlık 9'dan 13'e koruma gerektiren MIG, MAG, TIG ve PLAZMA KAYNAK için kullanılır.</p>	
RENK	SİYAH	

Product Properties

TYPES	<p>Self-darkening glass head for electric arc welding 9 to 13 protection is used for MIG, MAG, TIG and PLASMA WELDING low intensity and flame welding.</p>	
	<p>Self-darkening glass head for electric arc welding Used for MIG, MAG, TIG and PLASMA WELDING requiring 9 to 13 protection.</p>	
COLOUR	BLACK	

Produkt Eigenschaften

TYPEN	<p>Selbstverdunkelnder Glaskopf zum Lichtbogenschweißen 9 bis 13 Schutz wird zum MIG-, MAG-, TIG- und PLASMA-SCHWEISSEN mit niedriger Intensität und zum Flammenschweißen verwendet.</p>	
	<p>Selbstverdunkelnder Glaskopf zum Lichtbogenschweißen Wird beim MIG-, MAG-, WIG- und PLASMA-SCHWEISSEN verwendet, das einen Schutz von 9 bis 13 erfordert.</p>	
FARBE	SCHWARZ	

GÖZLÜKLER

GLASSES

BRILLE

Ürün Özellikleri		Product Properties		Produkt Eigenschaften	
MATERYAL	Polikarbonat tek camlı gözlük. Kaymaz, kauçuk, ayarlanabilir ve kademeli plastik saplar. Entegre TPE burun parçası. UV 400 CE EN166 EN170	MATERIAL	Polycarbonate single lens glasses. Non-slip, rubber, adjustable and graduated plastic handles. Integrated TPE nose piece. UV 400 CE EN166 EN170	MATERIAL	Einscheibenbrille aus Polycarbonat. Rutschfeste, gummierte, verstellbare und abgestufte Kunststoffgriffe. Integriertes TPE-Nasenstück. UV400 CE EN166 EN170



Ürün Özellikleri		Product Properties		Produkt Eigenschaften	
MATERYAL	Polikarbonat çift camlı gözlük. Kaymaz, kauçuk, ayarlanabilir ve kademeli plastik saplar. Entegre TPE burun parçası. UV 400 CE EN166 EN170	MATERIAL	Polycarbonate double lens glasses. Non-slip, rubber, adjustable and graduated plastic handles. Integrated TPE nose piece. UV 400 CE EN166 EN170	MATERIAL	Doppelglasbrille aus Polycarbonat. Rutschfeste, gummierte, verstellbare und abgestufte Kunststoffgriffe. Integriertes TPE-Nasenstück. UV400 CE EN166 EN170





GÖZLÜKLER

GLASSES

BRILLE

Ürün Özellikleri		Product Properties		Ürün Özellikleri	
	DETAIL Tek camlı polikarbonat gözlük üzeri gözlük. Yan siperler. Entegre polikarbonat burun parçası. Esnek polikarbonat saplar. Tüm numaralı gözlükler için uygundur. CE EN166 EN170	DETAIL	Single lens polycarbonate goggles over glasses. Side shields. Integrated polycarbonate nose piece. Flexible polycarbonate handles. Suitable for all prescription glasses. CE EN166 EN170	DETAIL	Einscheibenbrille aus Polycarbonat über einer Brille. Seitenschutz. Integriertes Nasenstück aus Polycarbonat. Flexible Griffe aus Polycarbonat. Für alle Korrektionsbrillen geeignet. CE EN166 EN170

Ürün Özellikleri		Product Properties		Ürün Özellikleri	
	DETAIL PVC koruma gözlüğü Polikarbonat cam Dolaylı havalandırma UV400	DETAIL	PVC protection glasses polycarbonate glass indirect ventilation UV400	DETAIL	PVC-Schutzbrille Polycarbonatglas indirekte Belüftung UV400



Ürün Özellikleri		Product Properties		Ürün Özellikleri	
	DETAIL Koruma gözlüğü Polikarbonat cam Dolaylı havalandırma Kimyasal dayanımlı neopren bant UV400	DETAIL	Protection goggles polycarbonate glass indirect ventilation Chemical resistant neoprene tape UV400	DETAIL	Schutzbrille Polycarbonatglas indirekte Belüftung Chemikalienbeständiges Neoprenband UV400

Ürün Özellikleri		Product Properties		Ürün Özellikleri	
	DETAIL Kaynakçı gözlük Polikarbonat cam UV400	DETAIL	Welder glasses Polycarbonate glass UV400	DETAIL	Schweißerbrille Polycarbonatglas UV400

GÖZLÜKLER

GLASSES

BRILLE

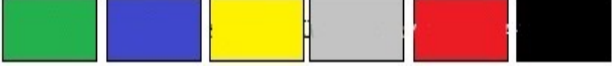
ÇEŞİTLERİ TYPES TYPEN	KLASİK	CROSS 603	CROSS 602
ÜRÜN GÖRSELİ PRODUCT IMAGE PRODUKTBILD			
AĞIRLIK (gram) WEIGHT (grams) GEWICHT (gramm)	28,00	23,20	23,70
RENK COLOUR FARBE			
SERTİFİKASYON CERTIFICATION ZERTIFIZIERUNG	<p>TSE EN 166 KAPSAMINDA VE CE BELGELİDİR. IT IS WITHIN THE SCOPE OF TSE EN 166 AND CE CERTIFIED. ES LIEGT IN DEN GELTUNGSBEREICH TSE EN 166 UND CE-ZERTIFIZIERT.</p>		
<p>KULLANIM AMACI Gözleri zararlı ve zehirli maddelerden ve bunların doğuracağı tehlikelerden koruyacak şekilde dizayn edilmiştir. Gözlük genellikle;</p> <ul style="list-style-type: none"> • Küçük parçalar ve tozlardan, • Talaş ve fırlayan büyük parçalar veya kıvılcımlardan, • Ultraviyole(UV) ve kızılötesi (IR) (ısı ışını) dahil sağlığa zararlı ışınlardan ve göz almadan, • Yüksek ısı püskürtme maddelerinden, • Kimyasal sıçramalar, erimiş metallere, • Zehirli gazlardan, gözleri korumak için kullanılır. 	<p>PURPOSE OF USAGE It is designed to protect the eyes from harmful and toxic substances and the dangers they may pose. Glasses are usually;</p> <ul style="list-style-type: none"> • Small parts and dust, • Sawdust and large flying pieces or sparks, • From harmful rays to health, including ultraviolet (UV) and infrared (IR) (heat rays) and without eye protection, • From high-temperature spraying agents, • Chemical splashes, molten metals, • It is used to protect eyes from toxic gases. 	<p>NUTZUNGSZWECK Es soll die Augen vor schädlichen und giftigen Stoffen und den Gefahren, die sie darstellen können, schützen. Gläser sind normalerweise;</p> <ul style="list-style-type: none"> • Kleinteile und Staub, • Sägemehl und große herumfliegende Teile oder Funken, • Vor gesundheitsschädlichen Strahlen, einschließlich Ultraviolett (UV) und Infrarot (IR) (Wärmestrahlen) und ohne Augenschutz, • von Hochtemperatur-Spritzmitteln, • Chemikalienspritzer, geschmolzene Metalle, • Es wird verwendet, um die Augen vor giftigen Gasen zu schützen. 	

KULAK TKAÇLARI

EAR PLUGS

OHRSTÖPSEL



Ürün Özellikleri

SİNYAL GÜRÜLTÜ ORANI	37dB
MATERYAL	Poliüretan Köpük
ÖZELLİKLER	Kablosuz
ÜRÜN TİPİ	Şekillendirilebilir
KORUMA ARALIĞI	95dB(A) - 110dB(A)
DETAY	Her bir çift kulak tıkacı ayrı ambalajlıdır. Birçok kulak yapısına uyum sağlar. Konforludur. Yüksek ses koruma düzeyi.

Product Properties

SIGNAL NOISE RATE	37dB
MATERIAL	Polyurethane Foam
FEATURES	Wireless
PRODUCT TYPE	Formable
PROTECTION RANGE	95dB(A) - 110dB(A)
DETAIL	Each pair of earplugs is individually packaged. It adapts to many ear structures. It is comfortable. High level of sound protection.

Produkt Eigenschaften

SIGNALRAUSCHRATE	37dB
MATERIAL	Polyurethanschäum
MERKMALE	Kabellos
PRODUKTART	Formbar
SCHUTZBEREICH	95dB(A) - 110dB(A)
DETAIL	Jedes Paar Ohrstöpsel ist einzeln verpackt. Es passt sich vielen Ohrstrukturen an. Es ist bequem. Hoher Schallschutz.

KULAK TKAÇLARI

EAR PLUGS

OHRSTÖPSEL



Ürün Özellikleri

SİNYAL GÜRÜLTÜ ORANI	34dB
MATERYAL	Poliüretan Köpük
ÖZELLİKLER	Kablolu
ÜRÜN TİPİ	Şekillendirilebilir
KORUMA ARALIĞI	95dB(A) - 110dB(A)
DETAY	Her bir çift kulak tıkacı ayrı ambalajlıdır. Birçok kulak yapısına uyum sağlar. Konforludur. Yüksek ses koruma düzeyi.

Product Properties

SIGNAL NOISE RATE	34dB
MATERIAL	Polyurethane Foam
FEATURES	Wired
PRODUCT TYPE	Formable
PROTECTION RANGE	95dB(A) - 110dB(A)
DETAIL	Each pair of earplugs is individually packaged. It adapts to many ear structures. It is comfortable. High level of sound protection.

Produkt Eigenschaften

SIGNALRAUSCHRATE	34dB
MATERIAL	Polyurethanschäum
MERKMALE	Verdrahtet
PRODUKTART	Formbar
SCHUTZBEREICH	95dB(A) - 110dB(A)
DETAIL	Jedes Paar Ohrstöpsel ist einzeln verpackt. Es passt sich vielen Ohrstrukturen an. Es ist bequem. Hoher Schallschutz.

KULAKLIK

EARMUFFS

KAPSELGEHÖRSCHUTZ



Ürün Özellikleri	
SİNYAL GÜRÜLTÜ ORANI	26dB
MATERYAL	Sarı ABS Dış Kabuk
ÖZELLİKLER	Baretle ve Koruyucu Başlıkla Kullanılabilir Tasarım
AĞIRLIK	168 gr
STANDARTLAR	89/686/EEC Direktiflerine Uygun, CE EN 352-1 Sertifikalı
KULLANIM ALANI	Tüm gürültülü ortamlarda, fabrika, atölye, tekstil fabrikaları, matbaa, yol çalışmaları, iş makineleri, elektrikli el aletleri, tarım uygulamaları, havaalanları, poligonlarda atış yaparken kullanımı yaygındır.
DETAY	Deri kaplı PVC kulak yastığı ve soft ekstra konforlu kafa bandı mevcuttur. Baretle ve koruyucu başlıkla kullanılabilir tasarıma sahiptir.

Product Properties	
SIGNAL NOISE RATE	26dB
MATERIAL	Yellow ABS Outer Shell
FEATURES	Usable Design with Helmet and Protective Hood
WEIGHT	168 gr
STANDARDS	Conforms to 89/686/EEC Directives, CE EN 352-1 Certified
USING AREA	It is widely used in all noisy environments, factories, workshops, textile factories, printing houses, road works, construction machinery, power tools, agricultural applications, airports, shooting ranges.
DETAIL	It has leather covered PVC ear cushions and a soft extra comfortable headband. It has a design that can be used with a helmet and protective hood.

Produkt Eigenschaften	
SIGNALRAUSCHRATE	26dB
MATERIAL	Gelbe ABS-Außenschale
MERKMALE	Nutzbares Design mit Helm und Schutzhaube
GEWICHT	168 gr
STANDARDS	Entspricht den Richtlinien 89/686/EWG, CE EN 352-1 zertifiziert
NUTZUNGSBEREICH	Es ist weit verbreitet in allen lauten Umgebungen, Fabriken, Werkstätten, Textilfabriken, Druckereien, Straßenarbeiten, Baumaschinen, Elektrowerkzeugen, landwirtschaftlichen Anwendungen, Flughäfen, Schießständen.
DETAIL	Es hat lederbezogene PVC-Ohrpolster und einen weichen, extra bequemen Kopfbügel. Es hat ein Design, das mit einem Helm und einer Schutzhaube verwendet werden kann.

POZİSYON ALMA KEMERİ

POSITIONING BELT

POSITIONIERUNGSGURT



Ürün Özellikleri	
TOKA	Otomatik Kilitli Paslanmaz Çelik
HALKA	8 mm Alüminyum D-Tipi
KOPMA MUKAVEMETİ	22 kN
ÜRÜN TİPİ	Polyester Kolon 45 mm
STANDARTLAR	CE EN 813:2008, CE EN 358

Product Properties	
CLIP	Auto Locked Stainless Steel
RING	8 mm Aluminium D-Type
TENSILE STRENGTH	22 kN
PRODUCT TYPE	Polyester Column 45 mm
STANDARDS	CE EN 813:2008, CE EN 358

Produkt Eigenschaften	
CLIP	Automatisch Gesperrt Rostfreier Stahl
RING	8 mm Aluminium D-Typ
ZUGFESTIGKEIT	22 kN
PRODUKTART	Polyestersäule 45 mm
STANDARDS	CE EN 813:2008, CE EN 358

BEL DESTEKLİ PARAŞÜT TİPİ EMNİYET KEMERİ

PARACHUTE TYPE SAFETY BELT WITH WAIST SUPPORT

PARACHUTE-SICHERHEITSGURT MIT TAILLENSTÜTZE



Ürün Özellikleri	
TOKA	Otomatik Kilitli Paslanmaz Çelik Üzeri Plastik Kaplı
HALKA	Otomatik kilitlemeli, yaylı ve nikel kaplamalı, Ø10 mm. çapında paslanmaz demir
KOLON GENİŞLİĞİ	48MM
TUTMA HALAT UZUNLUĞU	1200CM
STANDARTLAR	TS EN 361+EN 358 , CE EN 358+EN 361
DETAY	Paraşüt tipi emniyet kemerini, yüksekliği tabanda 180 cm. den fazla olan düşme veya kayma tehlikesi bulunan yerlerde (Bina, Fabrika, baraj inşaatlarında, yüksek gerilim hatları ile telefon direklerindeki bakım ve montaj işlerinde) çalışanlar, kiremit döşeyicileri, oluk ve her türlü dış cephe boya işleri yapanlar kullanır. Ayrıca, bu tür emniyet kemeri, kuyu, lağım, galeri ve kanalizasyonlarda, tehlikeli gaz ve buharların bulunduğu tanklarda bakım ve tamir işlerinde çalışan işçiler ile ilk yardım ve kurtarma çalışmalarında yaralı işçiler için de kullanılır.

Product Properties	
CLIP	Auto Locked Stainless Steel Over Plastic Coated
RING	Automatic locking, spring loaded and nickel plated, Ø10 mm. diameter stainless iron
COLUMN WIDTH	48MM
HOLD ROPE LENGTH	1200CM
STANDARDS	TS EN 361+EN 358 , CE EN 358+EN 361
DETAIL	Parachute type seat belt is used in places where there is a danger of falling or slipping more than 180 cm high from the ground. It is also used by those who work in the maintenance and assembly works of buildings, factories, dams, high voltage lines and telephone poles, tile layers, gutters and all kinds of exterior paint works. In addition, this type of seat belt is also used for workers working in maintenance and repair works in wells, sewers, galleries and sewers, tanks with dangerous gases and vapors, and injured workers in first aid and rescue work.

Produkt Eigenschaften	
CLIP	Automatisch Verriegelter Edelstahl Über Kunststoffbeschichtung
RING	Automatische Verriegelung, gefedert und vernickelt, Ø 10 mm. Durchmesser Edelstahl
SPALTENBREITE	48MM
SEILLÄNGE HALTEN	1200CM
STANDARDS	TS EN 361+EN 358 , CE EN 358+EN 361
DETAIL	Sicherheitsgurte vom Fallschirmtyp werden an Orten verwendet, an denen die Gefahr besteht, aus einer Höhe von mehr als 180 cm vom Boden zu fallen oder zu rutschen. Es wird auch von Personen verwendet, die bei Wartungs- und Montagearbeiten an Gebäuden, Fabriken, Dämmen, Hochspannungsleitungen und Telefonmasten, Fliesenlegern, Dachrinnen und allen Arten von Außenanstricharbeiten arbeiten. Darüber hinaus wird diese Art von Sicherheitsgurten auch für Arbeiter verwendet, die bei Wartungs- und Reparaturarbeiten in Brunnen, Kanälen, Stollen und Kanälen, Tanks mit gefährlichen Gasen und Dämpfen und verletzten Arbeitern bei Erste-Hilfe- und Rettungsarbeiten arbeiten.

EMNİYET HALATI

SAFETY ROPE

SICHERHEITSEIL



Ürün Özellikleri	
KALINLIK	12MM
UZUNLUK	1,2MT
HALAT UZUNLUĞU	2MT
MATERYAL	Polyester
STANDARTLAR	Karabina : CE 1015- EN362.2005-25KN Şok Emici (Polyester): CE 1019 - EN355.2002 Kancalar : CE 0082 - EN 362.2004/A Halat (%100 Polyamid) : CE 0194-EN354.2010
DETAY	Çift bacak lanyardı sayesinde yüksekte çalışan kişinin bir noktadan farklı bir noktaya güvenli bir şekilde geçmesini sağlar. Şok emici, düşüş yaşayan personel üzerine ilk darbe kuvveti ile oluşacak enerjiyi kademe kademe yırtılarak sönmüler ve personelin bedeninde oluşacak hasarı minimuma indirir.

Product Properties	
THICKNESS	12MM
LENGTH	1,2MT
ROPE LENGTH	2MT
MATERIAL	Polyester
STANDARDS	Carabiner : CE 1015-EN362.2005-25KN Shock Absorber (polyester): CE 1019 - EN355.2002 Hooks : CE 0082 - EN 362.2004/A Rope (100% Polyamide): CE 0194-EN354.2010
DETAIL	Thanks to its double leg lanyard, it allows the person working at height to pass from one point to another safely. The shock absorber absorbs the energy that will occur with the first impact force on the personnel who are in a fall, by gradually tearing them and minimizing the damage to the personnel's body.

Produkt Eigenschaften	
DICKE	12MM
LÄNGE	1,2MT
SEILLÄNGE	2MT
MATERIAL	Polyester
STANDARDS	Karabiner: CE 1015-EN362.2005-25KN Stoßdämpfer (Polyester): CE 1019 - EN355.2002 Haken: CE 0082 - EN 362.2004/A Seil (100 % Polyamid): CE 0194-EN354.2010
DETAIL	Dank seines zweisträngigen Verbindungsmittels ermöglicht es der Person, die in der Höhe arbeitet, sicher von einem Punkt zum anderen zu gelangen. Der Stoßdämpfer absorbiert die Energie, die mit der ersten Aufprallkraft auf die stürzende Person einwirkt, indem er sie allmählich zerreißt und die Körperverletzung der Person minimiert.

FOSFORLU İKAZ YELEĞİ

PHOSPHORUS WARNING VEST

PHOSPHOR-WARNVESTE



Ürün Özellikleri	
MATERYAL	100%Polyester
AĞIRLIK	125g
DETAY	Hafif ve konforlu. Görünürlüğü arttıran reflektif bant. Konforlu kullanım için geniş kesim. Kolay kullanım sağlayan cırt bantlı yapı

Product Properties	
MATERIAL	100%Polyester
WEIGHT	125g
DETAIL	Light and comfortable. Reflective tape to increase visibility. Wide cut for comfort. Velcro fastening for easy use.

Produkt Eigenschaften	
MATERIAL	100%Polyester
GEWICHT	125g
DETAIL	Leicht und bequem. Reflektierendes Band zur Erhöhung der Sichtbarkeit. Weit geschnitten für Komfort. Klettverschluss für einfache Handhabung

TEKNİSYEN YELEK

TECHNICIAN VEST

TECHNIKERWESTE



Ürün Özellikleri	
MATERYAL	100%Polyester
AĞIRLIK	130g
UZUNLUK	75CM
BEDEN SEÇENEKLERİ	XS, S, M, L, XL, XXL, 3XL
DETAY	Fermuarlı kaplama sistemi Ön, arka beden, göğüs ve omuzlarda 50 mm reflektif şeritler Sol göğüste kapaklı cep ve telsiz halkası. Sağ göğüste PVC isimlik Kapaklı üstten cepler

Product Properties	
MATERIAL	100%Polyester
WEIGHT	130g
LENGTH	75CM
SIZE OPTIONS	XS, S, M, L, XL, XXL, 3XL
DETAIL	Zipper closure system 50 mm reflective strips on front, back body, chest and shoulders Left chest flap pocket and radio loop. PVC nameplate on right chest Top pockets with flaps

Produkt Eigenschaften	
MATERIAL	100%Polyester
GEWICHT	130g
LÄNGE	75CM
GRÖSSENOPTIONEN	XS, S, M, L, XL, XXL, 3XL
DETAIL	Reißverschluss-System 50 mm Reflexstreifen auf Vorder- und Rückseite, Brust und Schultern Linke Brustpattentasche und Funkgeräteschlaufe. PVC-Namensschild auf der rechten Brust Obere Taschen mit Klappen

TAM YÜZ MASKESİ

FULL FACE MASK

VOLLGESICHTSMASKE



Ürün Özellikleri	
ÜRÜN TİPİ	Tam yüz maskesi
DETAY	Polikarbonat cam (210°). 4'lü filtre. Buğuyu azaltmak için içeride silikon yarım maske (3 nefes alma valfi, 1 nefes verme valfi, ses sistemi) ayarlanabilir beden. Saklama çantası mevcuttur. Tozlar ve/veya gazlar ve buharlarla çalışmaya uygundur.

Product Properties	
PRODUCT TYPE	Double filter half face mask
DETAIL	Polycarbonate glass (210°). 4 filter. Silicone half mask (3 inhalation valves, 1 exhalation valve, sound system) adjustable body inside to reduce misting. Storage bag is available. Suitable for working with powders and/or gases and vapors.

Produkt Eigenschaften	
PRODUKTART	Halbmaske mit Doppelfilter
DETAIL	Polycarbonatglas (210°). 4 Filter. Halbmaske aus Silikon (3 Einatemventile, 1 Ausatemventil, Soundsystem) verstellbarer Körper im Inneren, um das Beschlagen zu reduzieren. Aufbewahrungsbeutel ist vorhanden. Geeignet zum Arbeiten mit Pulvern und/oder Gasen und Dämpfen.

YARIM YÜZ MASKESİ

HALF FACE MASK

HALBGESICHTSMASKE



Ürün Özellikleri	
ÜRÜN TİPİ	Çift filtrelili yarım yüz maskesi
FİLTRE BAĞLANTISI	Bayonet
FİLTRE KONUMLANMASI	Yanal
BOY SEÇENEKLERİ	S, M, L
AĞIRLIK	100GR
DETAY	Tozlar ve/veya gazlar ve buharlarla çalışmaya uygundur.

Product Properties	
PRODUCT TYPE	Double filter half face mask
FILTER CONNECTION	Bayonet
FILTER POSITIONING	Lateral
LENGTH OPTIONS	S, M, L
WEIGHT	100GR
DETAIL	Suitable for working with powders and/or gases and vapors.

Produkt Eigenschaften	
PRODUKTART	Halbmaske mit Doppelfilter
FILTERANSCHLUSS	Bajonett
FILTERPOSITIONIERUNG	Seitlich
LÄNGENOPTIONEN	S, M, L
GEWICHT	100GR
DETAIL	Geeignet zum Arbeiten mit Pulvern und/oder Gasen und Dämpfen.

TOZ MASKESİ

DUST MASK

STAUBMASKE



Ürün Özellikleri	
ÇEŞİTLERİ	Ventilli dolomit kalıplı toz maskesi FFP3
	Ventilli dolomit kalıplı toz maskesi FFP2
	Organik buharlar için aktif karbon ventilli FFP2 toz maskesi Ayarlama için burun klipsi klips altında köpük kenar Dolomit Kalıp
	Aktif karbon FFP3 ventilli maske 4 katlı Ayarlama için burun klipsi Dolomit Kalıp
DETAY	Tozlar ve/veya gazlar ve buharlarla çalışmaya uygundur.

Product Properties	
TYPES	Vented dolomite molded dust mask FFP3
	Vented dolomite molded dust mask FFP2
	FFP2 dust mask with activated carbon valve for organic vapors Nose clip for adjustment foam edge under clip Dolomite Mold
	Active carbon FFP3 valve mask 4 floors Nose clip for adjustment Dolomite Mold
DETAIL	Suitable for working with powders and/or gases and vapors.

Produkt Eigenschaften	
TYPEN	Belüftete Dolomit-Formstaubmaske FFP3
	Belüftete Dolomit-Formstaubmaske FFP2
	FFP2-Staubmaske mit Aktivkohleventil für organische Dämpfe Nasenclip zur Anpassung Schaumstoffkante unter Clip Dolomit Schimmel
	Aktivkohle-FFP3-Ventilmaske 4 Etagen Nasenclip zur Anpassung Dolomit Schimmel
DETAIL	Geeignet zum Arbeiten mit Pulvern und/oder Gasen und Dämpfen.

İŞ ELDİVENLERİ

WORK GLOVES

ARBEITSHANDSCHUHE

ÇEŞİTLERİ TYPES TYPEN	STD350	STD1	STD2	STD2 FLEX	STD2 FLEX+	STD PRO
ÜRÜN GÖRSELİ PRODUCT IMAGE PRODUKTBILD						
DAYANIM SINIFI RESISTANCE CLASS WIDERSTANDSKLASSE	2111X	2121X	3121X	3121X	3121X	4121X
DOKUMA WOVEN TYPE GEWEBTER TYP	PAMUK COTTON BAUMWOLLE	PAMUK COTTON BAUMWOLLE	PAMUK COTTON BAUMWOLLE	PAMUK COTTON BAUMWOLLE	PAMUK COTTON BAUMWOLLE	PAMUK COTTON BAUMWOLLE
KAPLAMA COATING GLASUR	3/4 NİTRİL 3/4 NITRILE 3/4 NITRIL	3/4 NİTRİL 3/4 NITRILE 3/4 NITRIL	3/4 NİTRİL 3/4 NITRILE 3/4 NITRIL	3/4 NİTRİL 3/4 NITRILE 3/4 NITRIL	NİTRİL NITRILE NITRIL	3/4 NİTRİL 3/4 NITRILE 3/4 NITRIL
RENK COLOUR FARBE	SARI YELLOW GELB	SARI YELLOW GELB	SARI YELLOW GELB	SARI YELLOW GELB	SARI YELLOW GELB	SARI YELLOW GELB
BEDEN SIZES GRÖSSEN	9-10	9-10	9-10	9-10	9-10	9-10

ÇEŞİTLERİ TYPES TYPEN	STDP3	STDP5	STDP7	STDP10	STDP10pro	STDP ZEBRA	STDP PL9
ÜRÜN GÖRSELİ PRODUCT IMAGE PRODUKTBILD							
DAYANIM SINIFI RESISTANCE CLASS WIDERSTANDSKLASSE	2121X	3121X	3131X	3121X	3121X	3131X	4131X
DOKUMA WOVEN TYPE GEWEBTER TYP	POLYESTER	POLYESTER	POLYESTER	POLYESTER	POLYESTER	POLYESTER	POLYESTER
KAPLAMA COATING GLASUR	NİTRİL NITRILE NITRIL	NİTRİL NITRILE NITRIL	NİTRİL NITRILE NITRIL	PU	PU	NİTRİL NITRILE NITRIL	NİTRİL NITRILE NITRIL
RENK COLOUR FARBE	SARI-GRİ YELLOW-GREY GELB-GRAU	SARI YELLOW GELB	SARI YELLOW GELB	SİYAH BLACK SCHWARZ	SİYAH BLACK SCHWARZ	SİYAH-KIRMIZI BLACK-RED SCHWARZ-ROT	SİYAH-KIRMIZI BLACK-RED SCHWARZ-ROT
BEDEN SIZES GRÖSSEN	9-10	9-10	9-10	7-8-9-10	7-8-9-10	9-10	9-10

ELDIVENLER

GLOVES

HANDSCHUH

	Ürün Özellikleri	Product Properties	Produkt Eigenschaften
	DETAJ METAKARPAL KORUMA KESILMEYE KARŞI DAYANIKLI ÇİFT NİTRİL KAPLAMA SIRT VE PARMAK UÇLARINDA NEOPREN GÜÇLENDİRME DAYANIM SINIFI: 4X42DP	DETAIL METACARPAL PROTECTION CUT RESISTANT DOUBLE NITRILE COATING NEOPRENE REINFORCEMENT ON BACK AND FINGERS RESISTANCE CLASS: 4X42DP	DETAIL METAKARPAL SCHUTZ SCHNITTFEST DOPPELTE NITRILBESCHICHTUNG NEOPREN-VERSTÄRKUNG AN RÜCKEN UND FINGERN WIDERSTANDSKLASSE: 4X42DP
	DETAJ METAKARPAL KORUMA TITREŞİM ÖNLEYİCİ KLOROPEN KAUÇUK DOLGU İLE GÜÇLENDİRİLMİŞ AVUÇ İÇİ VE PARMAK UÇLARI NEOPREN SIRT GÜÇLENDİRMESİ DAYANIM SINIFI: 4242XP	DETAIL METACARPAL PROTECTION HAND AND FINGER TIPS, REINFORCED WITH ANTI-VIBRATION CHLOROPEN RUBBER FILLING, NEOPRENE BACK REINFORCEMENT RESISTANCE CLASS: 4242XP	DETAIL METAKARPAL SCHUTZ HAND- UND FINGERSPITZEN, VERSTÄRKT MIT ANTIVIBRATIONSFÜLLUNG AUS CHLOROPEN-GUMMI, NEOPREN- RÜCKENVERSTÄRKUNG WIDERSTANDSKLASSE: 4242XP
	DETAJ TAM NİTRİL KAPLI AVUÇ İÇİ VE PARMAKLAR ÇİFT NİTRİL KAPLI ELDIVEN SU GEÇİRMEZ DAYANIM SINIFI: 3121X	DETAIL FULL NITRILE COATED HAND AND FINGERS DOUBLE NITRILE COATED GLOVES WATERPROOF RESISTANCE CLASS: 3121X	DETAIL VOLLSTÄNDIG NITRILBESCHICHTET HAND UND FINGER DOPPELTES NITRIL BESCHICHTETE HANDSCHUHE WASSERDICHT WIDERSTANDSKLASSE: 3121X
	DETAJ PAMUK FLOKLU NİTRİL ELDIVEN UZUNLUK 33 CM BAKTERİ MANTAR ÖNLEYİCİ DAYANIM SINIFI: 4101X	DETAIL COTTON FLOCKED NITRILE GLOVES LENGTH 33CM BACTERIAL ANTI-FUNGARY RESISTANCE CLASS: 4101X	DETAIL NITRIL-HANDSCHUHE AUS BAUMWOLLE LÄNGE 33CM BAKTERIELLE ANTI-FUNKUNG WIDERSTANDSKLASSE: 4101X
	DETAJ PAMUK FLOKLU LATEKS ELDIVEN UZUNLUK 30 CM 100 DERECE ISI TEMAS DAYANIMI BAKTERİ MANTAR ÖNLEYİCİ DAYANIM SINIFI: 4121X	DETAIL COTTON FLOCKED LATEX GLOVES LENGTH 30CM 100 DEGREES HEAT CONTACT RESISTANCE BACTERIAL ANTI-FUNGARY RESISTANCE CLASS: 4121X	DETAIL HANDSCHUHE AUS BAUMWOLLFLOCKTEM LATEX LÄNGE 30CM 100 GRAD HITZEKONTAKTBESTÄNDIGKEIT BAKTERIELLE ANTI-FUNKUNG WIDERSTANDSKLASSE: 4121X
	DETAJ PAMUK FLOKLU NEOPREN ELDIVEN UZUNLUK 33 CM KALINLIK 0,75 MM BAKTERİ MANTAR ÖNLEYİCİ DAYANIM SINIFI: 3110X	DETAIL COTTON FLOCKED NEOPRENE GLOVES LENGTH 33CM THICKNESS 0.75 MM BACTERIAL ANTI-FUNGARY RESISTANCE CLASS: 3110X	DETAIL HANDSCHUHE AUS BAUMWOLLFLOCKTEM NEOPREN LÄNGE 33CM DICKE 0,75 MM BAKTERIELLE ANTI-FUNKUNG WIDERSTANDSKLASSE: 3110X
	DETAJ KİMYASAL PVC PAMUK DOKUMA ASTAR ÜSTÜNE PVC 62 CM UZUNLUK BAKTERİ MANTAR ÖNLEYİCİ DAYANIM SINIFI: 4131X	DETAIL CHEMICAL PVC COTTON WEAVING PVC ON PRIMER 62 CM LENGTH BACTERIAL ANTI-FUNGARY RESISTANCE CLASS: 4131X	DETAIL CHEMISCHES PVC BAUMWOLLE WEBEN PVC AUF GRUNDIERUNG 62 CM LÄNGE BAKTERIELLE ANTI-FUNKUNG WIDERSTANDSKLASSE: 4131X
	DETAJ PAMUK JARSE ASTAR ÜSTÜNE TAM PVC KAPLAMA HİDROKARBÜR UZUNLUK 30 CM BAKTERİ MANTAR ÖNLEYİCİ DAYANIM SINIFI: 4131X	DETAIL FULL PVC COATING HYDROCARBIDE ON COTTON JARSE LINER LENGTH 30CM BACTERIAL ANTI-FUNGARY RESISTANCE CLASS: 4131X	DETAIL VOLLSTÄNDIGE PVC- BESCHICHTUNG MIT KOHLENWASSERSTOFF AUF BAUMWOLJARSE-LINER LÄNGE 30CM BAKTERIELLE ANTI-FUNKUNG WIDERSTANDSKLASSE: 4131X

KORUYUCU TULUMLAR

PROTECTIVE OVERALLS

SCHUTZ-OVERALLS



Ürün Özellikleri

Polipropilen maddeden dokumasız olarak üretilmiştir
4 katmandır
Yüksek geçirmezliğe sahiptir
El ve ayak bilekleri elastiktir
Bel kısmında elastik büzgü bulunmaktadır
Bağlantı yerleri kapatılmıştır
Anti-Statiktir

Product Properties

Made of non-woven polypropylene material
It is 4 layers
It has high impermeability
Wrists and ankles are elastic
There is an elastic drawstring at the waist
Connections are closed
It is Anti-Static

Produkt Eigenschaften

Hergestellt aus Polypropylen-Vliesstoff
Es sind 4 Schichten
Es hat eine hohe Undurchlässigkeit
Handgelenke und Knöchel sind elastisch
In der Taille befindet sich ein elastischer Kordelzug
Verbindungen sind geschlossen
Es ist antistatisch

RENK/ COLOUR/ FARBE	BEDEN/ SIZE/ SCHUHGRÖSSE	STANDARD
BEYAZ/ WHITE/ WEISS	XL XXL	CE EN 1149-1 CAT.3 TIP 5-6

SÜET S01 İŞ AYAKKABISI

SAFETY SHOES

SICHERHEITSSCHUHE



Ürün Özellikleri

Poliüretan tek ve çift dansiteli (katmanlı) taban seçeneği.
Yumuşak İç Taban
Hava Geçirgen Astar
Süet
Çelik Burunlu

Product Properties

Polyurethane single and double density (layered) sole choice.
Soft Insole
Air Permeable Primer
Suede
Steel Toe

Produkt Eigenschaften

Sohlenauswahl aus Polyurethan mit einfacher und doppelter Dichte (geschichtet).
Weiche Innensohle
Luftdurchlässige Grundierung
Deri
Wildleder

RENK/ COLOUR/ FARBE	BEDEN/ SIZE/ SCHUHGRÖSSE	STANDARD
SİYAH/ BLACK/ SCHWARZ	EUR 36	CE EN 20343
SİYAH/ BLACK/ SCHWARZ	EUR 37	CE EN 20344
SİYAH/ BLACK/ SCHWARZ	EUR 38	CE EN 20345
SİYAH/ BLACK/ SCHWARZ	EUR 39	CE EN 20345
SİYAH/ BLACK/ SCHWARZ	EUR 40	CE EN 20345
SİYAH/ BLACK/ SCHWARZ	EUR 41	CE EN 20345
SİYAH/ BLACK/ SCHWARZ	EUR 42	CE EN 20345
SİYAH/ BLACK/ SCHWARZ	EUR 43	CE EN 20345
SİYAH/ BLACK/ SCHWARZ	EUR 44	CE EN 20345
SİYAH/ BLACK/ SCHWARZ	EUR 45	CE EN 20345
SİYAH/ BLACK/ SCHWARZ	EUR 46	CE EN 20345

DERİ S02 İŞ AYAKKABISI

SAFETY BOATS

SICHERHEITSBOOTE



Ürün Özellikleri

Poliüretan tek ve çift dansiteli (katmanlı) taban seçeneği.
Yumuşak İç Taban
Hava Geçirgen Astar
Deri
Çelik Burunlu

Product Properties

Polyurethane single and double density (layered) sole choice.
Soft Insole
Air Permeable Primer
Deri
Steel Toe

Produkt Eigenschaften

Sohlenauswahl aus Polyurethan mit einfacher und doppelter Dichte (geschichtet).
Weiche Innensohle
Luftdurchlässige Grundierung
Deri
Stahlkappe

RENK/ COLOUR/ FARBE	BEDEN/ SIZE/ SCHUHGRÖSSE	STANDARD
SİYAH/ BLACK/ SCHWARZ	EUR 36	CE EN 20343
SİYAH/ BLACK/ SCHWARZ	EUR 37	CE EN 20344
SİYAH/ BLACK/ SCHWARZ	EUR 38	CE EN 20345
SİYAH/ BLACK/ SCHWARZ	EUR 39	CE EN 20345
SİYAH/ BLACK/ SCHWARZ	EUR 40	CE EN 20345
SİYAH/ BLACK/ SCHWARZ	EUR 41	CE EN 20345
SİYAH/ BLACK/ SCHWARZ	EUR 42	CE EN 20345
SİYAH/ BLACK/ SCHWARZ	EUR 43	CE EN 20345
SİYAH/ BLACK/ SCHWARZ	EUR 44	CE EN 20345
SİYAH/ BLACK/ SCHWARZ	EUR 45	CE EN 20345
SİYAH/ BLACK/ SCHWARZ	EUR 46	CE EN 20345

DERİ S02 KAYNAKÇI İŞ AYAKKABISI

SAFETY SHOES

SICHERHEITSSCHUHE



Ürün Özellikleri

Poliüretan tek ve çift dansiteli (katmanlı) taban seçeneği.
Yumuşak İç Taban
Hava Geçirgen Astar
Deri
Çelik Burunlu

Product Properties

Polyurethane single and double density (layered) sole choice.
Soft Insole
Air Permeable Primer
Deri
Steel Toe

Produkt Eigenschaften

Sohlenauswahl aus Polyurethan mit einfacher und doppelter Dichte (geschichtet).
Weiche Innensohle
Luftdurchlässige Grundierung
Deri
Stahlkappe

RENK/ COLOUR/ FARBE	BEDEN/ SIZE/ SCHUHGRÖSSE	STANDARD
SİYAH/ BLACK/ SCHWARZ	EUR 40	CE EN 20345
SİYAH/ BLACK/ SCHWARZ	EUR 41	CE EN 20345
SİYAH/ BLACK/ SCHWARZ	EUR 42	CE EN 20345
SİYAH/ BLACK/ SCHWARZ	EUR 43	CE EN 20345
SİYAH/ BLACK/ SCHWARZ	EUR 44	CE EN 20345
SİYAH/ BLACK/ SCHWARZ	EUR 45	CE EN 20345
SİYAH/ BLACK/ SCHWARZ	EUR 46	CE EN 20345

YAĞMURLUK

RAINCOAT

REGENJACKE

KALINLIK (mc) THICKNESS (mc) DICKE (mc)	25	32	
RENK COLOUR FARBE	Sarı, Yeşil ve Mavi Yellow, Green and Blue Gelb, Grün und Blau	Sarı, Yeşil ve Mavi Yellow, Green and Blue Gelb, Grün und Blau	
ASTAR TECHNICAL DETAILS TECHNISCHE DETAILS	Astarsız Unlayered Ungeschichtet	Polyester Polyester Polyester	
MALZEME MATERIAL	PVC	PVC	
TEKNİK ÖZELLİKLER TECHNICAL DETAILS TECHNISCHE DETAILS	Suya dayanıklı yapı, kapüşon, çit çit ve fermuar seçeneği, 2 ön cep Waterproof construction, hoodie, snap and zipper choice, 2 front pockets Wasserdichte konstruktion, hoodie, druckknopf- und reißverschlussauswahl, 2 vordertaschen		

STD KIMYASAL

SPREY BOYA

SPRAY PAINT

SPRÜHFARBE



Ölçü Dimension Messung	Ağırlık Weight Gewicht
400 ml	320 g



KİMYASAL DÜBEL

CHEMICAL ANCHOR

CHEMISCHER ANKER

ÇEŞİTLERİ TYPES TYPEN	345ml	410ml	
MALZEME MATERIAL MATERIAL	POLYESTER REÇİNE BAZLIDIR.		
SICAKLIK ARALIĞI TEMPERATURE RANGE TEMPERATURBEREICH	-40°C +120°C	-40°C +120°C	
SERTİFİKASYON CERTIFICATION ZERTIFIZIERUNG	CE, TSE		
RAF ÖMRÜ SHELF LIFE HALTBARKEIT	18 AY 18 MONTHS 18 MONATE		
UYGULAMA ALANLARI USAGE AREAS EINSATZBEREICHE	Beton, mermer, taş vb. ankraj ve yapıştırma işlerinde, makine ve sistemlerin ankraj ve montaj işlerinde kullanılır. Concrete, marble, stone etc. It is used in anchoring and bonding works, anchoring and assembly works of machines and systems. Beton, Marmor, Stein etc. Es wird bei Verankerungs- und Klebearbeiten, Verankerungs- und Montagearbeiten von Maschinen und Anlagen eingesetzt.		

SİLİKONİZE MASTİK

SILICONE SEALANT

SILIKON DICHTUNGSMITTEL



Ürün Özellikleri

Hızlı Uygulama
Kuvvetli Sızdırmazlık
UV Işınlara Dayanıklılık

Product Properties

Quick Application
Strong Sealing
UV Resistant

Produkt Eigenschaften

Schnelle Anwendung
Starke Versiegelung
UV, beständig

Raf Ömrü Shelf life Haltbarkeit	12 ay / 12 month / 12 Monate
Ağırlık Weight Gewicht	500 g
Kullanım Alanı Usage Area Einsatzbereich	Alüminyum, Cam, Seramik, Metal Aluminium, Glass, Ceramic, Metal Aluminium, Glas, Keramik, Metall
Renk Seçenekleri Colour Options Farboptionen	

SİLİKON

SILICON

SILIZIUM



Ürün Özellikleri

Hızlı Uygulama
Kuvvetli Sızdırmazlık
UV Işınlara Dayanıklılık

Product Properties

Quick Application
Strong Sealing
UV Resistant

Produkt Eigenschaften

Quick Application
Strong Sealing
UV Resistant

Raf Ömrü Shelf life Haltbarkeit	12 ay / 12 month / 12 Monate
Ağırlık Weight Gewicht	300 g
Kullanım Alanı Usage Area Einsatzbereich	Alüminyum, Cam, Seramik, Banyo, Mutfak Aluminium, Glaskeramik, Bad, Küche Aluminium, Glass, Ceramic, Bathroom, Kitchen
Renk Seçenekleri Colour Options Farboptionen	

AKVARYUM SİLİKONU

AQUARIUM SILICONE

AQUARIUM-SILIKON



Ürün Özellikleri

Hızlı Uygulama
Kuvvetli Sızdırmazlık
UV Işınlara Dayanıklı

Product Properties

Quick Application
Strong Sealing
UV Resistant

Produkt Eigenschaften

Schnelle Anwendung
Starke Versiegelung
UV, beständig

Raf Ömrü Shelf life Haltbarkeit	12 ay / 12 month / 12 Monate
Ağırlık Weight Gewicht	300 g
Kullanım Alanı Usage Area Einsatzbereich	Alüminyum, Cam, Seramik, Metal Aluminum, Glass, Ceramic, Metal Aluminium, Glas, Keramik, Metall

DUŞAKABİN SİLİKONU

SHOWER CABIN SILICONE

DUSCHKABINE SILIKON



Ürün Özellikleri

Hızlı Uygulama
Kuvvetli Sızdırmazlık
UV Işınlara Dayanıklı

Product Properties

Quick Application
Strong Sealing
UV Resistant

Produkt Eigenschaften

Quick Application
Strong Sealing
UV Resistant

Raf Ömrü Shelf life Haltbarkeit	12 ay / 12 month / 12 Monate
Ağırlık Weight Gewicht	300 g
Kullanım Alanı Usage Area Einsatzbereich	Cam, Metal, Yağlı olmayan ahşap Glass, Metal, Non, oil wood Glas, Metall, Nicht geöltes Holz

HIZLI YAPIŐTIRICI

SUPER GLUE

SEKUNDENKLEBER

ÜRÜN TANIMI PRODUCT DESCRIPTION PRODUKTBESCHREIBUNG	STD 801	
AĞIRLIK (gram) WEIGHT (grams) GEWICHT (gramm)	20 g	
SICAKLIK ARALIĐI TEMPERATURE RANGE TEMPERATURBEREICH	-54°C +82°C	
RENK COLOUR FARBE	SAYDAM TRANSPARENT	
NİHAİ ÇEKME KUVVETİ (N/mm) ENDGÜLTIGE ZUGKRAFT (N/mm) FINAL TENSILE FORCE (N/mm)	~200	
VİSKOZİTE (Cp) VISCOSITY (Cp) VİSKOSİTÄT (Cp)	2 - 5	

İLK TUTUŐ SÜRESİ	FIRST HOLD TIME	ERSTES HALTEN MAL
KAUÇUK İLE KAUÇUK RUBBER WITH RUBBER GUMMI MIT GUMMI		< 3 saniye < 3 second < 3 zweite
PLASTİK İLE PLASTİK KUNSTSTOFF MIT KUNSTSTOFF PLASTIC WITH PLASTIC		< 5 saniye < 5 second < 5 zweite
METAL İLE METAL METAL WITH METAL METALL MIT METALL		< 10 saniye < 10 second <10 zweite

POLİÜRETAN KÖPÜK

POLYURETHANE FOAM

POLYURETHANSCHAUM



Ürün Özellikleri

Hızlı Uygulama
Ekstra Formül
Çok Amaçlı

Product Properties

Quick Application
Extra Formula
Multipurpose

Produkt Eigenschaften

Schnelle Anwendung
Zusätzliche Formel
Mehrzweck

Raf Ömrü
Shelf life
Haltbarkeit

12 ay / 12 month / 12 Monate

Ağırlık
Weight
Gewicht

600 g

Kullanım Alanı
Usage Area
Einsatzbereich

Kapı pencere montajı, Boşluk doldurma, Ses ve Isı izolasyon
Door and window installation, Gap filling, Sound and Heat insulation
Tür- und Fenstereinbau, Fugenfüllung, Schall- und Wärmedämmung

SİLİKON VE EPOKSİ TABANCI

SILICONE AND EPOXY GUNS

SILIKON UND EPOXIDPISTOLE

ÇEŞİTLERİ TYPES TYPEN	SİLİKON PLASTİK SILICONE PLASTIC SILIKON KUNSTSTOFF	SİLİKON METAL SILICONE METAL SILIKON-METALL	EPOKSİ 345 ml EPOXY 345 ml EPOXID 345 ml	EPOKSİ 410 ml EPOXY 410 ml EPOXID 410 ml
AĞIRLIK (gram) WEIGHT (grams) GEWICHT (gramm)	265	533	664	810
MALZEME MATERIAL	PLASTİK PLASTIC KUNSTSTOFF	METAL METALL	METAL METALL	METAL METALL
TEK BASKIDA İLERLEYİŞİ PROGRESS IN ONE PRINT FORTSCHRITT IN EINEM DRUCK	8 - 10 mm	5 - 7 mm	5 - 7 mm	5 - 7 mm
RENK COLOUR FARBE	SİYAH BLACK SCHWARZ	SİYAH BLACK SCHWARZ	SİYAH BLACK SCHWARZ	SİYAH, KIRMIZI BLACK, RED SCHWARZ, ROT
TEKNİK ÇİZİM TECHNICAL DRAWING TECHNISCHE ZEICHNUNG				
ÜRÜN GÖRSELİ PRODUCT IMAGE PRODUKTBILD				

STD FIRÇA

KESTİRME FIRÇALARI

SHORT BRUSHES



KURZE BÜRSTEN

ÜRÜN ADI	LİBRA KESTİRME FIRÇALARI	LUNA KESTİRME FIRÇALARI	LUNA FİRST KESTİRME FIRÇALARI	STERKEL KESTİRME FIRÇALARI
ÜRÜN GÖRSELİ				
ÇEŞİTLERİ	NO: 1- 1,5- 2- 2,5- 3- 4	NO: 1- 1,5- 2- 2,5- 3- 4	NO: 1- 1,5- 2- 2,5- 3- 4	NO: 1- 1,5- 2- 2,5- 3- 4- 5
DETAY	Su bazlı boyalar için tasarlanmıştır. Ergonomik sap yapısına sahiptir, kullanımı kolaydır. Kıl, iz bırakmaz ve uzun ömürlüdür.			

KESTİRME FIRÇALARI

SHORT BRUSHES



KURZE BÜRSTEN

ÜRÜN ADI	LUNA POLYMIX KESTİRME FIRÇALARI	LUNA BLACK AĞAÇ SAPLI KESTİRME FIRÇALARI	LUNA BLACK AĞAÇ SAPLI SÜPER KESTİRME FIRÇALARI
ÜRÜN GÖRSELİ			
ÇEŞİTLERİ	NO: 1- 1,5- 2- 2,5- 3- 4	NO: 1- 1,5- 2- 2,5- 3- 4	NO: 3- 4
DETAY	Geri dönüştürülmüş pet hammaddeneden üretilmiş, uzun ömürlü ürünlerdir. Su bazlı boyalar için tasarlanmıştır. Ergonomik sap yapısına sahiptir. Kullanımı kolaydır. Kıl, iz bırakmaz.		

POLYESTER FIRÇALARI

POLYESTER BRUSHES

POLYESTERBÜRSTEN

ÜRÜN ADI	LUNA POLYESTER FIRÇALARI	LUNA VERNİK FIRÇALARI
ÜRÜN GÖRSELİ		
ÇEŞİTLERİ	NO: 3- 4	NO: 1- 1,5- 2- 2,5- 3- 4
DETAY	Profesyonel polyester ustalarının kullanabileceği şekilde tasarlanmıştır. Selülozik tinere dayanıklıdır.	

AKROBAT YAĞLI BOYA FIRÇALARI

ACROBAT FLAT BRUSHES

ACROBAT-FLACHPINSEL

ÜRÜN ADI	LUNA AKROBAT YAĞLI BOYA FIRÇALARI	STERKEL AKROBAT YAĞLI BOYA FIRÇALARI
ÜRÜN GÖRSELİ		
ÇEŞİTLERİ	NO: 2- 2,5- 3- 4- 5	NO: 3- 4- 5
DETAY	Su bazlı boya ve yağlı boya kullanımı için uygundur. Oynar başlığı ve sap takabilme özelliği sayesinde zor ve yüksek noktalara kolayca ulaşım sağlar.	

KALORİFER FIRÇALARI

HEATER BRUSHES

HEIZBÜRSTEN

ÜRÜN ADI	LUNA KALORİFER FIRÇALARI
ÜRÜN GÖRSELİ	
ÇEŞİTLERİ	NO: 2- 3
DETAY	Erişimi güç noktalar için tasarlanmıştır. Kıl ve iz bırakmaz.

YAĞLI BOYA FIRÇALARI

OIL PAINT BRUSHES

ÖLFARBENPINSEL

ÜRÜN ADI	BLOK YAĞLI BOYA FIRÇALARI	LUNA JUNIOR YAĞLI BOYA FIRÇALARI	LUNA YAĞLI BOYA FIRÇALARI	LUNA BLACK YAĞLI BOYA FIRÇALARI
ÜRÜN GÖRSELİ				
ÇEŞİTLERİ	3x7, 3x10, 3x12, 4x14, 5x15	NO: 1- 1,5- 2- 2,5- 3- 4	NO: 1- 1,5- 2- 2,5- 3- 4	NO: 1- 1,5- 2- 2,5- 3- 4- 5
DETAY	Yağlı boyalar için tasarlanmıştır. Sapları ergonomiktir. Kıl ve iz bırakmaz.			

YAĞLI BOYA FIRÇALARI

OIL PAINT BRUSHES

ÖLFARBENPINSEL

ÜRÜN ADI	STERKEL YAĞLI BOYA FIRÇALARI	APOLLO YAĞLI BOYA FIRÇALARI	CASTOR YAĞLI BOYA FIRÇALARI
ÜRÜN GÖRSELİ			
ÇEŞİTLERİ	NO: 1- 1,5- 2- 2,5- 3- 4	NO: 1- 1,5- 2- 2,5- 3- 4	NO: 1- 1,5- 2- 2,5- 3- 4
DETAY	Yağlı boyalar için tasarlanmıştır. Sapları ergonomiktir. Kıl ve iz bırakmaz.		

PARMAK RULOLAR

MINI ROLLERS

MINI-ROLLEN

ÜRÜN ADI	GÖKKUŞAĞI PARMAK RULO TAKIM	PARMAK POLYAMİD LÜKS RULOLAR TAKIM
ÜRÜN GÖRSELİ		
ÇEŞİTLERİ	5cm, 10 cm, 15cm	5cm, 10 cm, 15cm
DETAY	Su bazlı ve yağlı boyalar için tasarlanmıştır. Tüy ve iz bırakmaz. Rulo sapları sırk takılabilir özelliktedir.	

SATEN RULOLAR

SATIN ROLLERS



SATINROLLEN

ÜRÜN ADI	GÖKKUŞAĞI SATEN RULO	EKSTRA SATEN LÜKS SARI ÇİZGİ RULO	EKSTRA SATEN GOLD RULO	EXTRA SATEN RULO
ÜRÜN GÖRSELİ				
ÇEŞİTLERİ	20cm, 25cm	20cm, 25cm	20cm, 25cm	20cm, 25cm
DETAY	Polyamid kumaştan üretilmiştir. Silikon bazlı ve akrilik esaslı boyalarda kullanılır. Tüy ve iz bırakmaz. Rulo sapları sırk takılabilir özelliktedir.			

İÇ - DIŞ CEPHE RULOLARI

INTERIOR - EXTERIOR PAINTING ROLLERS

MALERROLLEN FÜR DEN INNEN- UND AUSSENBEREICH

ÜRÜN ADI	GÖKKUŞAĞI PROFESYONEL RULOLAR	İÇ - DIŞ LÜKS PLASTİK CEPHE RULOLAR	İÇ - DIŞ EKSTRA YEŞİL RULOLAR	İÇ - DIŞ EGE MAVİSİ RULOLAR
ÜRÜN GÖRSELİ				
ÇEŞİTLERİ	20cm, 25cm	20cm, 25cm	20cm, 25cm	20cm, 25cm
DETAY	Plastik ve su bazlı boyalar için tasarlanmıştır. Tüy ve iz bırakmaz. Rulo sapları sırk takılabilir özelliktedir.			

MOHER RULOLAR

MOHER ROLLERS

MOHER ROLLEN

ÜRÜN ADI	PARMAK MOHER RULOLAR	MOHER RULOLAR
ÜRÜN GÖRSELİ		
ÇEŞİTLERİ	5cm, 10 cm, 15cm	20cm, 25cm
DETAY	Vernik ve yağlı boya uygulamalarında kullanılır. Pürüzsüz bir yüzey elde etmek için kullanılır. Rulo sapları sırk takılabilir özelliktedir.	

EPOKSİ RULOLAR

EPOXY ROLLERS

EPOXIDROLLEN

ÜRÜN ADI	PARMAK EPOKSİ RULOLAR	EPOKSİ RULOLAR
ÜRÜN GÖRSELİ		
ÇEŞİTLERİ	10 cm, 15cm	20cm, 25cm
DETAY	Epoksi uygulamalarında kullanılır. Tüy, iz bırakmaz, boya sıçratmaz. Yağlı boya, antipas ve vernikler için kullanılır. Rulo sapları sırk takılabilir özelliktedir.	

SÜNGER RULOLAR

FOAM ROLLERS

SCHAUMSTOFFROLLEN

ÜRÜN ADI	MERCAN SÜNGER RULOLAR	MERCAN SÜNGER DELİKLİ RULOLAR	PARMAK SÜNGER RULOLAR	SÜNGER RULOLAR
ÜRÜN GÖRSELİ				
ÇEŞİTLERİ	20cm, 25cm	20cm, 25cm	5cm, 10 cm, 15cm	20cm, 25cm
DETAY	Kabarcıksız ve pürürsüz bir boyama için yüksek yoğunlukta süngerden imal edilmiştir. Vernik, cam cila, yağlı boyalar ile kullanılır. Rulo sapları sırk takılabilir özelliktedir.			

POSTAKİ RULOLAR

LAMBSKIN ROLLERS

LAMMFELLROLLEN

ÜRÜN ADI	PARMAK POSTAKİ RULOLAR	POSTAKİ EKSTRA RULOLAR
ÜRÜN GÖRSELİ		
ÇEŞİTLERİ	10 cm	20cm, 25cm
DETAY	Doğal postekiden üretilmiştir. Düzgün satıh bırakır. Su esaslı, silikonlu boyalar, vernik, polyester ve akrilik boyalarda kullanılır. Rulo sapları sırk takılabilir özelliktedir.	

SÜNGER ÜSTÜ KADİFE RULOLAR

FLOCKED FOAM PAINT ROLLERS

FARBROLLEN AUS BEFLOCKTEM SCHAUMSTOFF

ÜRÜN ADI	SÜNGER ÜSTÜ KADİFE RULOLAR	SÜNGER ÜSTÜ KADİFE RULOLAR YEDEK	RULO SAPLARI
ÜRÜN GÖRSELİ			
ÇEŞİTLERİ	5cm, 10 cm, 15cm	5cm, 10 cm, 15cm	5cm, 10 cm, 15cm, 20cm, 25cm
DETAY	Kusursuz bir boyama için üzeri kadife kaplı yüksek yoğunluklu süngerden imal edilmiştir. Vernik, cam cila, yağlı boyalar ile kullanılır. Rulo sapları sırk takılabilir özelliktedir.		

EKSTRA LÜKS RULOLAR

EKSTRA LÜKS RULOLAR	EXTRA LUXURIÖSE ROLLEN	
ÜRÜN ADI	EKSTRA LÜKS SATEN RULO - SWAN	EKSTRA LÜKS PLASTİK BOYA RULOSU - TIGER
ÜRÜN GÖRSELİ		
ÇEŞİTLERİ	20cm, 25cm	20cm, 25cm
DETAY	%100 polyamid kumaştan üretilmiş olup, su ve solvent bazlı boyalarda kullanılabilir. Özellikle alçı yüzeylerde saten boya uygulamalarında mükemmel sonuç verir.	Mikcopolyester kumaş ve bükümlü iptan üretilmiş olup su ve solvent bazlı boyalarda kullanılabilir. İç ve dış cephelerde plastik ve akrilik esaslı boya uygulamalarında mükemmel sonuç verir.

KORUYUCU ÖRTÜLER

DROP SHEET	DROP-BLATT	
ÜRÜN ADI	KALIN PRATİK BRANDA GRUBU	İNCE PRATİK BRANDA GRUBU
ÜRÜN GÖRSELİ		
ÇEŞİTLERİ	10 m ² , 20 m ² , 32 m ² , 50 m ² ,	10 m ² , 20 m ² , 32 m ² , 50 m ² ,



KALEM FIRÇA GRUBU

RIGGER BRUSHES	RIGGER-BÜRSTEN	
ÜRÜN ADI	NALBUR TİPİ KALEM FIRÇA YUVARLAK	SULU BOYA RÖTUŞ FIRÇASI YUVARLAK
ÜRÜN GÖRSELİ		
ÇEŞİTLERİ	NO: 6, 8, 10, 12, 14,16, 18, 20, 22, 24	NO: 0, 1, 2, 3, 4, 5, 6, 7, 8, 9,10, 11, 12

MALA VE ISPATULA GRUBU

TROWEL AND SPATULA GROUP

GRUPPE KELLE UND SPACHEL

ÜRÜN ADI	AĞAÇ SAPLI ISPATULA	PLASTİK SAPLI ISPATULA	TEMİZLİK ISPATULA	GENİŞ MACUN ISPATULALARI
ÜRÜN GÖRSELİ				
ÇEŞİTLERİ	NO: 6, 8, 10, 12, 14,18	NO: 6, 8, 10, 12, 14,18	NO: 40, 60, 80, 100, 120, 140	NO: 17, 22, 30

ÜRÜN ADI	AĞAÇ SAPLI ALÇI MALALARI	AĞAÇ SAPLI SERAMİK MALALARI (KARE DİŞ)	GENİŞ MACUN ISPATULALARI	MACUN KÜREKLERİ (PLASTİK SAPLI)
ÜRÜN GÖRSELİ				
ÇEŞİTLERİ	NO: 30, 35, 40	NO: 30, 35, 40	NO: 18, 20	NO: 16, 18, 20

ÜRÜN ADI	EKO PLASTİK SAPLI ALÇI MALALARI	EKO PLASTİK SAPLI SERAMİK MALALARI (KARE DİŞ)	EĞRİ SAPLI ISPATULALAR (PLASTİK SAP)	PLASTİK SAPLI ALÇI MALALARI
ÜRÜN GÖRSELİ				
ÇEŞİTLERİ	NO: 30, 35, 40	NO: 30, 35, 40	NO: 20, 25, 30, 40	NO: 30, 35, 40

ÜRÜN ADI	PLASTİK SAPLI SERAMİK MALALARI (ÜÇGEN DİŞ)	PLASTİK SAPLI SERAMİK MALALARI (KARE DİŞ)	ÇOK AMAÇLI ISPATULA	OTO ISPATULALARI
ÜRÜN GÖRSELİ				
ÇEŞİTLERİ	NO: 30, 35	NO: 30, 35, 40		4'LÜ TAKIM

ÜRÜN ADI	SÜNGERLİ TİRFİL MALALAR	DERZ MALALARI	SÜNGERLİ ve KAUÇUKLU MALALAR	KALETERASİT MALASI
ÜRÜN GÖRSELİ				
ÇEŞİTLERİ	KISA- UZUN	KISA- UZUN	SÜNGERLİ- KAUÇUKLU	

TEMİZLİK ÜRÜNLERİ

CLEANING PRODUCTS

REINIGUNGSMITTEL

ÜRÜN ADI	OTO FIRÇALARI	OTO FIRÇALARI	OTO FIRÇALARI	OTO FIRÇALARI
ÜRÜN GÖRSELİ				
ÇEŞİTLERİ	NORMAL, BATTAL, BATTAL LÜKS	SÜPER EKSTRA, SÜPER EKSTRA LÜKS	LUNA LONGO, LUNA GOLD, LUNA PLATIN	TIGER 24 CM, TIGER 30 CM

ÜRÜN ADI	YER SÜPÜRME FIRÇALARI	LÜKS YER SÜPÜRME FIRÇALARI	BAHÇE SÜPÜRGELERİ	JUMBO YER FIRÇALARI
ÜRÜN GÖRSELİ				
ÇEŞİTLERİ	TÜYLÜ, DÜZ, SERT	TÜYLÜ, DÜZ, SERT, EKSTRA, TAHTA FIRÇASI	30cm, 40cm, 50cm, 60cm	40cm SERT, 40cm TÜYLÜ

ÜRÜN ADI	AĞAÇ ÇALI FIRÇA	AĞAÇ ÇALI FIRÇA APARATLARI	ENDÜSTRİYEL YER FIRÇALARI
ÜRÜN GÖRSELİ			
ÇEŞİTLERİ	30cm, 40cm	PLASTİK, BÜYÜK GEÇMELİ	40cm, 50cm, 60cm, 80cm, 100cm

TEMİZLİK SETLERİ

MOP BUCKET SETS

MOP-EIMER-SETS



ÜRÜN ADI	DÖNER BAŞLIKLILIK TEMİZLİK SETİ	TABLET SET	TEMİZLİK SETİ TAKIM
ÜRÜN GÖRSELİ			

MOP ÇEŞİTLERİ



MOP GROUPS

MOP-GRUPPEN

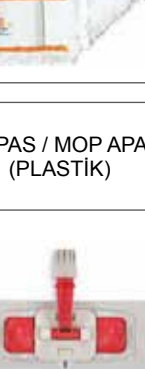
ÜRÜN ADI	İPLİK MOPLAR	HAVLU MOPLAR	ENDÜSTRİYEL İP MOPLAR
ÜRÜN GÖRSELİ			

ÜRÜN ADI	KASKAN MOPLAR	ISLAK MOPLAR	ISLAK MOP APARATLARI
ÜRÜN GÖRSELİ			

ÜRÜN ADI	NEMLİ PASPAS / MOP İP	NEMLİ PASPAS / MOP MİKROFİBER	MİKROFİBER MAKARNA PASPAS
ÜRÜN GÖRSELİ			

ÜRÜN ADI	NEMLİ PASPAS / MOP APARATLARI (TEL)	NEMLİ PASPAS / MOP APARATLARI (PLASTİK)	PRESLİ TEMİZLİK SETİ
ÜRÜN GÖRSELİ			

ÇÖP KONTEYNERLERİ

GARBAGE CONTAINERS



MÜLLBEHÄLTER

ÜRÜN ADI	ÇÖP KONTEYNERİ 80 LT	ÇÖP KONTEYNERİ 120 LT	ÇÖP KONTEYNERİ 240 LT
ÜRÜN GÖRSELİ			

KAPI ALTI FIRÇALARI

UNDERDOOR BRUSHES

UNTERTÜRBÜRSTEN

ÜRÜN ADI	ALÜMİNYUM H TİPİ	ALÜMİNYUM T TİPİ	KAPI ALTI FIRÇASI KENDİNDEN YAPIŞKANLI
ÜRÜN GÖRSELİ			
ÇEŞİTLERİ	90 CM- 100 CM	90 CM- 100 CM	90 CM- 100 CM

SIRIK GRUBU

HANDLE GROUP

GRIFFGRUPPE

ÜRÜN ADI	İTHALA METAL SIRIKLAR	ÖZEL AHŞAP SIRIKLAR (PASOLU)	METAL TELESKOPIK SIRIKLAR
ÜRÜN GÖRSELİ			
ÇEŞİTLERİ	1.20 M- 1.30 M	1.20 M- 1.50 M- 2 M- 2.50 M	2 M- 3 M- 4 M- 6 M

ÜRÜN ADI	ALÜMİNYUM APARATLI SIRIKLAR	İTHAL ALÜMİNYUM SIRIKLAR	VERNİKLİ GÜRGEN SIRIKLAR
ÜRÜN GÖRSELİ			
ÇEŞİTLERİ	1,5 M- 2 M 3 M- 4M	2 M 3 M- 4M- 6 M- 9 M	1.20 M

STD DÜZENLEYİCİLER

TAKIM ÇANTASI

TOOL BOX

WERKZEUGKASTEN

ÜRÜN GÖRSELİ		
ÜRÜN ADI	COMBO	
ÇEŞİTLERİ	18	22
ÖLÇÜLERİ	(WxLxH) mm 260 x 430 x 250	(WxLxH) mm 275 x 525 x 295

TAKIM ÇANTASI

TOOL BOX

WERKZEUGKASTEN

ÜRÜN GÖRSELİ		
ÜRÜN ADI	COMPACTO	
ÇEŞİTLERİ	16	20
ÖLÇÜLERİ	(WxLxH) mm 270 x 380 x 220	(WxLxH) mm 290 x 500 x 240

TAKIM ÇANTASI

TOOL BOX

WERKZEUGKASTEN

ÜRÜN GÖRSELİ				
ÜRÜN ADI	STILO Organizerli			
ÇEŞİTLERİ	13	16	19	22
ÖLÇÜLERİ	(WxLxH) mm 173x334x140	(WxLxH) mm 227x409x190	(WxLxH) mm 287x488x237	(WxLxH) mm 350x559x284

TAKIM ÇANTASI

TOOL BOX

WERKZEUGKASTEN

ÜRÜN GÖRSELİ				
ÜRÜN ADI	APEX Organizerli			
ÇEŞİTLERİ	13	16	19	22
ÖLÇÜLERİ	(WxLxH) mm 173x334x140	(WxLxH) mm 227x409x190	(WxLxH) mm 287x488x237	(WxLxH) mm 350x559x284

TAKIM ÇANTASI

TOOL BOX

WERKZEUGKASTEN

ÜRÜN GÖRSELİ			
ÜRÜN ADI	STRONGO		
ÇEŞİTLERİ	16	18	21
ÖLÇÜLERİ	(WxLxH) mm 210x395x177	(WxLxH) mm 233x458x247	(WxLxH) mm 276x535x267

TAKIM ÇANTASI

TOOL BOX

WERKZEUGKASTEN

ÜRÜN GÖRSELİ			
ÜRÜN ADI	EKO STRONGO		
ÇEŞİTLERİ	16	18	21
ÖLÇÜLERİ	(WxLxH) mm 210x395x177	(WxLxH) mm 233x458x247	(WxLxH) mm 276x535x267

TAKIM ÇANTASI

TOOL BOX

WERKZEUGKASTEN

ÜRÜN GÖRSELİ			
ÜRÜN ADI	META Organizerli		
ÇEŞİTLERİ	19	22	24
ÖLÇÜLERİ	(WxLxH) mm 255x480x230	(WxLxH) mm 295x555x265	(WxLxH) mm 314x607x277

TAKIM ÇANTASI

TOOL BOX

WERKZEUGKASTEN

ÜRÜN GÖRSELİ			
ÜRÜN ADI	EKO META		
ÇEŞİTLERİ	19	22	
ÖLÇÜLERİ	(WxLxH) mm 255x480x230	(WxLxH) mm 295x555x265	

TAKIM ÇANTASI

TOOL BOX

WERKZEUGKASTEN

ÜRÜN GÖRSELİ					
ÜRÜN ADI	MAESTRO Organizerli				
ÇEŞİTLERİ	13	16	19	22	24
ÖLÇÜLERİ	(WxLxH) mm 150x320x135	(WxLxH) mm 200x410x180	(WxLxH) mm 230x480x230	(WxLxH) mm 290x555x265	(WxLxH) mm 340x600x320

TAKIM ÇANTASI

TOOL BOX

WERKZEUGKASTEN

ÜRÜN GÖRSELİ				
ÜRÜN ADI	EKONO Organizerli			
ÇEŞİTLERİ	13	16	19	22
ÖLÇÜLERİ	(WxLxH) mm 160x320x130	(WxLxH) mm 200x400x175	(WxLxH) mm 255x480x230	(WxLxH) mm 295x555x265

TAKIM ÇANTASI

TOOL BOX

WERKZEUGKASTEN

ÜRÜN GÖRSELİ		
ÜRÜN ADI	MOBİL	
ÇEŞİTLERİ	18 MOBİL ÇİFT ÇANTA	24 ORGANİZERLİ MOBİL
ÖLÇÜLERİ	(WxLxH) mm 270x450x585	(WxLxH) mm 340x600x320

TAKIM ÇANTASI

TOOL BOX

WERKZEUGKASTEN

ÜRÜN GÖRSELİ		
ÜRÜN ADI	RAFLI MAESTRO	
ÇEŞİTLERİ	17	20
ÖLÇÜLERİ	(WxLxH) mm 210x440x195	(WxLxH) mm 250x495x230

TAKIM ÇANTASI

TOOL BOX

WERKZEUGKASTEN

ÜRÜN GÖRSELİ				
ÜRÜN ADI	BASIC SERİSİ - MAESTRO SEPETLİ			
ÇEŞİTLERİ	13	16	19	22
ÖLÇÜLERİ	(WxLxH) mm 150x320x135	(WxLxH) mm 210x410x175	(WxLxH) mm 230x480x220	(WxLxH) mm 290x555x265

TAKIM ÇANTASI

TOOL BOX

WERKZEUGKASTEN

ÜRÜN GÖRSELİ				
ÜRÜN ADI	MATKAP			
ÇEŞİTLERİ	MATKAP ÇANTASI	MATKAP ÇANTASI ORGANİZERLİ	SİYAH GÖVDE RENKLİ KİLİT	USTA EL ALETİ ÇANTASI
ÖLÇÜLERİ	(WxLxH) mm 300x405x140	(WxLxH) mm 300x405x155	(WxLxH) mm 220x225x72 270x330x80 350x500x110	(WxLxH) mm 330x440x190



ÇEKMECE MODÜLLERİ

DRAWER MODULES

SCHUBLADENMODULE

ÜRÜN GÖRSELİ				
ÜRÜN ADI	HOBBY SET 1- 2- 3- 4- 5- 6			
ÇEŞİTLERİ	KIRMIZI, MAVİ, SİYAH			
ÖLÇÜLERİ	(WxLxH) mm: 120x225x280 - 120x450x335 - 140x340x255 - 140x425x335 - 120x112x225 - 140x450x339			

ORGANİZER

ORGANİZER				VERANSTALTER
ÜRÜN GÖRSELİ				
ÜRÜN ADI	POLYMAX/ DOUBLE			
ÇEŞİTLERİ	POLY MAX 32 ORGANİZER	POLY MAX 38 ORGANİZER	POLY MAX 48 ORGANİZER	POLY MAX DOUBLE ORGANİZER
ÖLÇÜLERİ	(WxLxH) mm 270 x 330 x 60	(WxLxH) mm 210 x 389 x 67	(WxLxH) mm 373 x 470 x 80	(WxLxH) mm 270 x 320 x 60

ORGANİZER

ORGANİZER			VERANSTALTER
ÜRÜN GÖRSELİ			
ÜRÜN ADI	POLY		
ÇEŞİTLERİ	POLY ORGANİZER 1/8, 2/12, 3/8 KIRMIZI, MAVİ	POLY ORGANİZER 32, 38, 48	POLY ORGANİZER 31/16, 41/24, SET
ÖLÇÜLERİ	(WxLxH) mm 140x165x35, 155x265x40, 180x303x80	(WxLxH) mm 265x320x50, 300x380x60, 375x480x75	(WxLxH) mm 255x300x54, 370x400x58, 279x322x297

AVADANLIKLAR

STORAGE BINS					LAGERBEHÄLTER
ÜRÜN GÖRSELİ					
ÜRÜN ADI	AVADANLIK				
ÇEŞİTLERİ	NO:1	NO:2	NO:3	NO:4	NO:5
RENK	KIRMIZI, MAVİ, SİYAH	KIRMIZI, MAVİ, SİYAH	KIRMIZI, MAVİ, SİYAH	KIRMIZI, MAVİ, SİYAH	KIRMIZI, MAVİ, SİYAH
ÖLÇÜLERİ	(WxLxH) mm 82x100x52	(WxLxH) mm 165x100x82	(WxLxH) mm 230x153x125	(WxLxH) mm 335x210x165	(WxLxH) mm 505x320x200

AVADANLIK DOLAPLARI

STORAGE CABINETS

VLAGERSCHRÄNKE

ÜRÜN GÖRSELİ			
ÜRÜN ADI	AVADANLIK DOLAPLARI		
ÇEŞİTLERİ	KAPAKLI AVADANLIK DOLABI 1	KAPAKLI AVADANLIK DOLABI 2	KAPAKLI AVADANLIK DOLABI 3
ÖLÇÜLERİ	(WxLxH) mm 400x1600x900	(WxLxH) mm 260x1600x700	(WxLxH) mm 400x1600x900

MODÜLLER

MODULAR GROUP

MODULARE GRUPPE

ÜRÜN GÖRSELİ		
ÜRÜN ADI	MODÜLLER	
ÇEŞİTLERİ	GEZER DÖNER MODÜL	EKSENEL MODÜL
ÖLÇÜLERİ	(WxLxH) mm 630x630x1150	(WxLxH) mm 840x970x1520 880x1010x1540 880x1010x1560

STD AŐINDIRICILAR

KESME ve TAŞLAMA TAŞLARI

ÜRÜN BİLGİLERİ

- 1 Kalite kategorisi
- 2 Uygulanacak malzeme
- 3 Ölçüler (çap x kalınlık x delik çapı)
- 4 Ürün spesifikasyonu
- 5 Maksimum devir hızı
- 6 Uygulama tipi (Kesme / Taşlama)
- 7 Ürün kodu
- 8 OSA Sertifika logosu
- 9 Avrupa Standartı EN12413

KESME TAŞLARI METAL / İNOX

CUTTING WHEELS

SCHNEIDERÄDER

ÜRÜN GÖRSELİ				
ÇAP (mm)	115	125	180	230
KALINLIK x DELİK ÇAPI (mm)	1,0x22,23	1,0x22,23	1,6x22,23	2,0x22,23
SPESİFİKASYON	A 60 R	A 60 R	A 46 R	A 36 R
KULLANIM ALANI	Aşındırıcıların çelik endüstrisinde oldukça geniş bir kullanım alanı bulunuyor; gemi yapımı, parça üretimi, otomotiv ve inşaat bileşenleri, özel profiller, borular, elektrikli ürünler, araç-gereç ve makinaların bakım ve tamiri.			

TAŞLAMA TAŞLARI METAL

GRINDING WHEELS

SCHLEIFSCHEIBEN

ÜRÜN GÖRSELİ				
ÇAP (mm)	115	125	180	230
KALINLIK x DELİK ÇAPI (mm)	6,0x22,23	6,0x22,23	6,0x22,23 8,0x22,23	6,0x22,23 8,0x22,23
SPESİFİKASYON	A 24 Q	A 24 Q	A 24 Q	A 24 Q
KULLANIM ALANI	Aşındırıcıların çelik endüstrisinde oldukça geniş bir kullanım alanı bulunuyor; gemi yapımı, parça üretimi, otomotiv ve inşaat bileşenleri, özel profiller, borular, elektrikli ürünler, araç-gereç ve makinaların bakım ve tamiri.			

KESME TAŞLARI METAL / İNOX

CUTTING WHEELS

SCHNEIDERÄDER

ÜRÜN GÖRSELİ			
ÇAP (mm)	115	180	230
KALINLIK x DELİK ÇAPI (mm)	1,0x22,23	2,0x22,23	1,9x22,23 2,0x22,23
SPESİFİKASYON	A 60 S	A 30 S	A 46 S A 30 S
KULLANIM ALANI	Aşındırıcıların çelik endüstrisinde oldukça geniş bir kullanım alanı bulunuyor; gemi yapımı, parça üretimi, otomotiv ve inşaat bileşenleri, özel profiller, borular, elektrikli ürünler, araç-gereç ve makinaların bakım ve tamiri.		

KESME TAŞLARI METAL / İNOX

CUTTING WHEELS

SCHNEIDERÄDER

ÜRÜN GÖRSELİ				
ÇAP (mm)	115	125	180	230
KALINLIK x DELİK ÇAPI (mm)	3,0x22,23	3,0x22,23	3,0x22,23 3,2x22,23	3,0x22,23 3,8x22,23 3,2x22,23
SPESİFİKASYON	A30 S	A30 S	A30 S	A30 S
KULLANIM ALANI	Aşındırıcıların çelik endüstrisinde oldukça geniş bir kullanım alanı bulunuyor; gemi yapımı, parça üretimi, otomotiv ve inşaat bileşenleri, özel profiller, borular, elektrikli ürünler, araç-gereç ve makinaların bakım ve tamiri.			

TAŞLAMA TAŞLARI METAL / İNOX

GRINDING WHEELS

SCHLEIFSCHEIBEN

ÜRÜN GÖRSELİ				
ÇAP (mm)	115	125	180	230
KALINLIK x DELİK ÇAPI (mm)	6,4x22,23	6,4x22,23	6,4x22,23 8,0x22,23	6,4x22,23 8,0x22,23
SPESİFİKASYON	A 24 P A 30 P	A 30 P	A 24 P A 30 P	A 30 P
KULLANIM ALANI	Aşındırıcıların çelik endüstrisinde oldukça geniş bir kullanım alanı bulunuyor; gemi yapımı, parça üretimi, otomotiv ve inşaat bileşenleri, özel profiller, borular, elektrikli ürünler, araç-gereç ve makinaların bakım ve tamiri.			

FLAP DİSKLER

Norton flap diskler; işlem süresini azaltan ve toplam ürün maliyetini düşüren, hafif talaş kaldırma, pah kırma, çapak giderme, kaynak dikişinin temizlenmesi ve finisaj işlemleri için tasarlanmıştır.

Flap diskler; fiber disklere nazaran daha hızlı bir uygulama ve daha iyi bir yüzey finisajı sunar.

Bunun yanı sıra, flap yapısı sayesinde daha uzun bir kullanım ömrü sağlar.

FLAP DİSKLER METAL / İNOX

FLAP DISCS

FLAMMSCHEIBEN

ÜRÜN GÖRSELİ		
ÇAP x DELİK (mm)	115 x 22	180 x 22
KUM	40 - 60 - 80	40 - 60 - 80
KULLANIM ALANI	Alüminyum oksit aşındırıcı dayanıklı flap disk Uzun ömürlü ve düzgün finisaj sağlar	

FLAP DİSKLER METAL / İNOX

FLAP DISCS

FLAMMSCHEIBEN

ÜRÜN GÖRSELİ		
ÇAP x DELİK (mm)	115 x 22	180 x 22
KUM	40 - 60 - 80 - 120	40 - 60 - 80 - 120
KULLANIM ALANI	Çelik ve paslanmaz çeliğin çapağının giderilmesi ve kaba taşlama işlemleri için çok amaçlı ürün Kendiliğinden keskinleşen zirkonyum aşındırıcı mineral Orta ve düşük basınçta yüksek & düzenli kesme hızı Mükemmel fiyat & performans oranı	